

# AIRWAY MANAGEMENT PRODUCTS

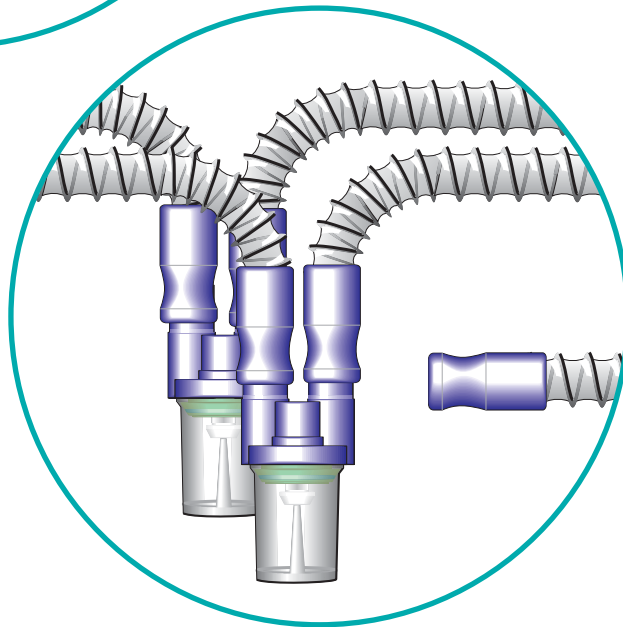
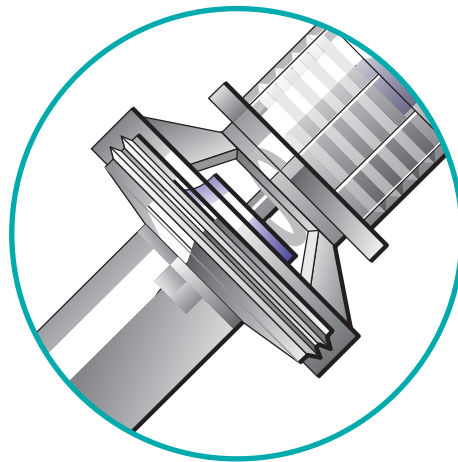
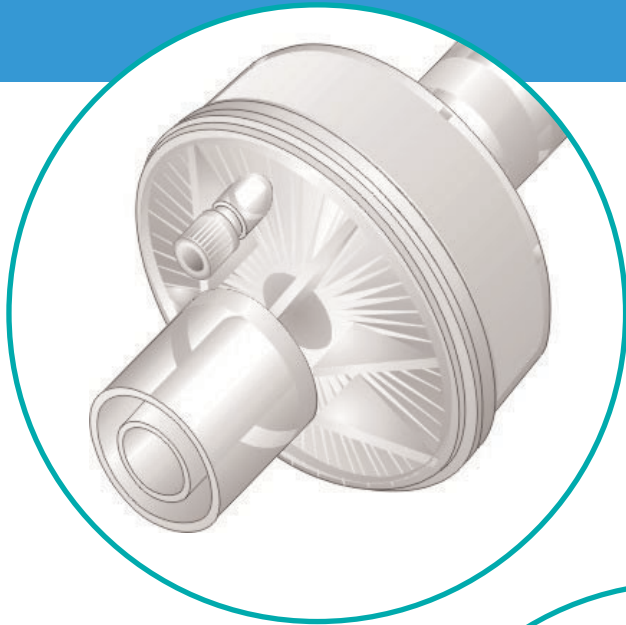

meditech  
systems limited

# WELCOME TO OUR NEW AIRWAY MANAGEMENT CATALOGUE

Meditech Systems Quality Accessories for airway management

**M**editech is a well established British based manufacturer which has been manufacturing anaesthesia now launched a new range of anaesthesia and respiratory products for a number of years. previously we have only offered these products to Trade customers on an OEM basis; but have now decided to launch the **AIRWAY** range. The **AIRWAY** range offers value for money without compromising on quality and are designed to meet the high quality standards of each market.



Cleanroom assembly

## QUALITY

All products carry the **CE** mark  
EEC DIR 93/42/EEC

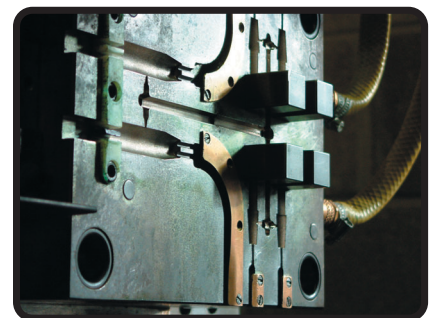

Injection moulding



## CONFIGURE

Custom designs available.  
Ask for our design program on CD Design and be quoted immediately on your own pc!

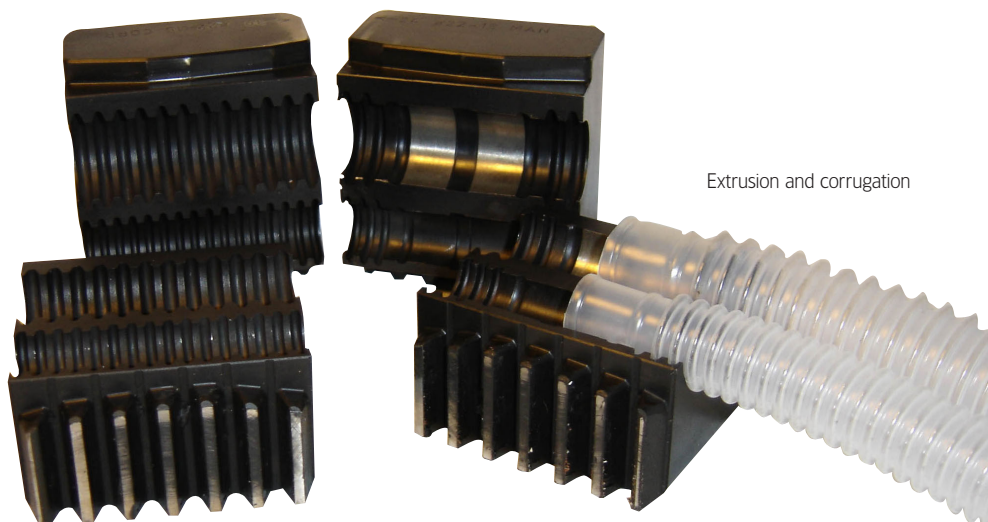

Extrusion and corrugation

+44 (0) 1258 471 770  
+44 (0) 1258 471 772

Tel Fax

Meditech Systems Limited  
Unit 3 Richmar  
Butt's Pond Ind.Estate  
Sturminster Newton  
Dorset DT10 1AZ

**NEW**  
user friendly  
**ORDERING**  
**SOFTWARE**

# CONFIGURE

Custom design and quotation software

Intuitive, user friendly software which allows you to create your own custom circuit and get a price immediately

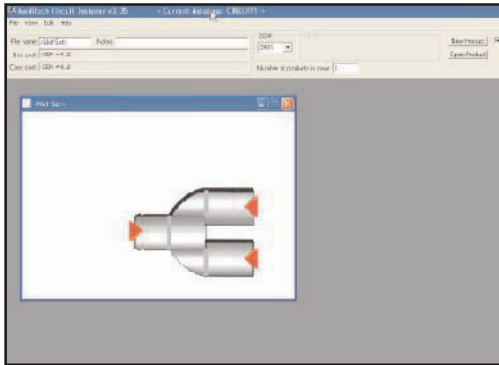

**1** Using the red link arrows you can activate the automatic size recognition which searches components for correct fitting. One click on the component required and it is added to the circuit. Price is being calculated as you build.

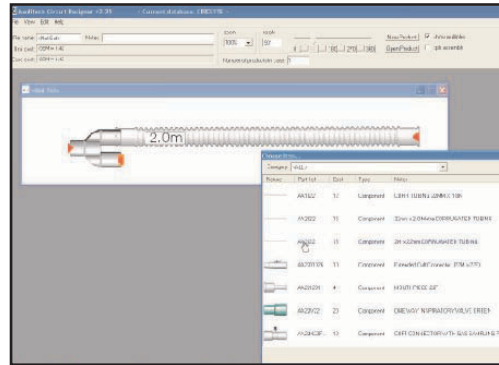

**2** Choose the component you require from the list of compatible components. Click on your required component and it is added to the design, still calculating the cost as you continue to build your design.

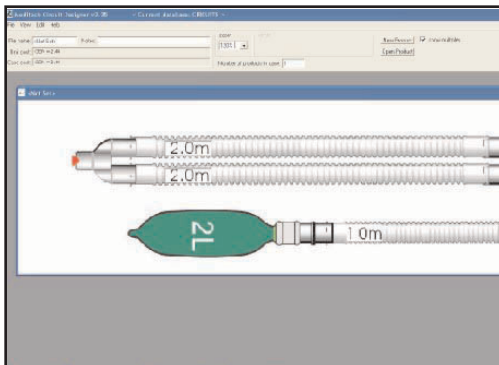

**3** Once the design is complete. You enter your unique reference number and export it to Meditech via print, email or mobile phone picture export. We will then build your sample for trial use.

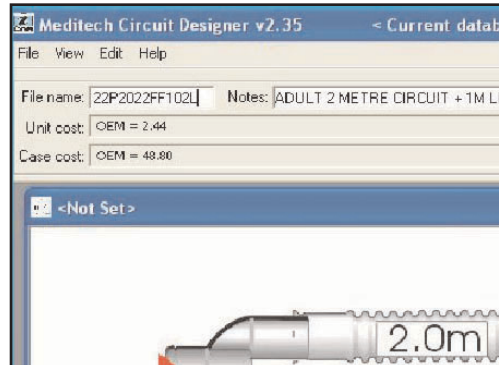

**4** The program holds all standard designs on file, allowing an automatic search to check if your design has already been created. If previously created your design will be available from our stock. new customer designs turn around in days.

## CONFIGURE

Developed by ICAN Software Ltd

Configure is available to all Meditech dealers along with a full comprehensive product offering in anaesthesia and respiratory products. contact customer service for your installation CD:

**T. +44(0)1258 471 770**  
**F. +44(0)1258 471 772**



## List of contents

VENTILATOR CIRCUITS	4-6	INTENSIVE CARE CIRCUITS	10-11	FILTERS AND HME'S	14	venturi masks systems	18
CATHETER MOUNTS AND BAGS	7	SMOOTHBORE CIRCUITS	11-12	ANAESTHESIA MASKS GAS SAMPLING LINES	15	drug nebulisers	19
APL VALVE CIRCUITS deluxe bain	8-9	EXTENDIBLE CIRCUITS	13	OXYGEN THERAPY aerosol masks and tubing oxygen masks and nasal cannulae	16-19 16 17	ACCESSORIES AND CONNECTORS	20-21
						RESUSCITATION	22-23

**STANDARD 'Y' PIECE CIRCUITS**

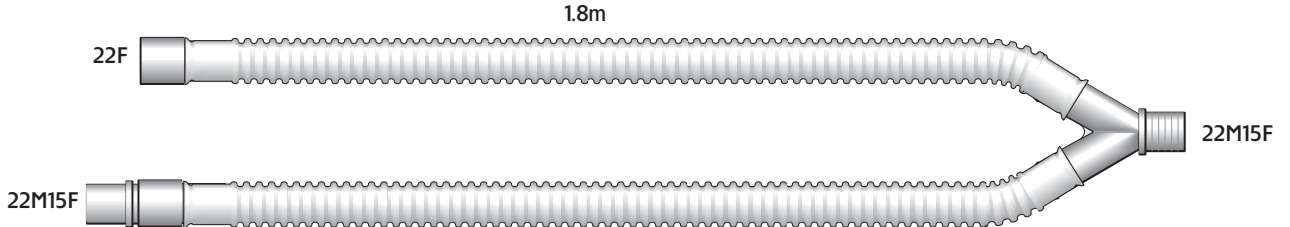

CODE	DESCRIPTION	BOX QTY
221622FF	Circuit 1.6m Length Basic Design	10
221822FF	Circuit 1.8m Length Basic Design	10
222422FF	Circuit 2.4m Length Basic Design	10
223022FF	Circuit 3.0m Length Basic Design	10
221622FM	Circuit 1.6m Length w/22mm connector	10
221822FM	Circuit 1.8m Length w/22mm connector	10
221622FM10	Circuit 1.6m Length w/22mm conn+ 1.0m limb	10
221822FM10	Circuit 1.6m Length w/22mm conn+ 1.0m limb	10
221622FM102L	Circuit 1.6m length w/22mm conn + 1.0m + 2Lbag	10
221822FM102L	Circuit 1.6m length w/22mm conn + 1.0m + 2Lbag	10

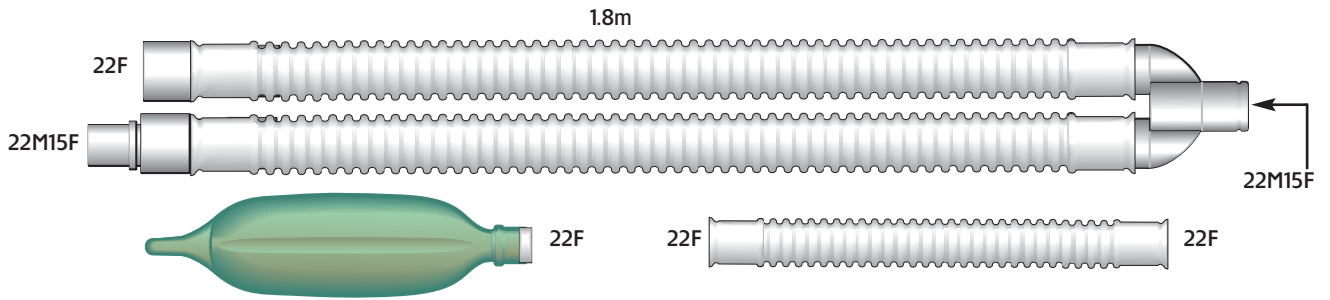

CODE	DESCRIPTION	BOX QTY
22P1622FF	Circuit 1.6m Length Basic Design	10
22P1822FF	Circuit 1.8m Length Basic Design	10
22P2422FF	Circuit 2.4m Length Basic Design	10
22P3022FF	Circuit 3.0m Length Basic Design	10
22P1622FM	Circuit 1.6m Length w/22mm connector	10
22P1822FM	Circuit 1.8m Length w/22mm connector	10
22P1622FM10	Circuit 1.6m Length w/22mm conn+ 1.0m limb	10
22P1822FM10	Circuit 1.8m Length w/22mm conn+ 1.0m limb	10
22P1622FM102L	Circuit 1.6m length w/22mm conn + 1.0m + 2Lbag	10
22P1822FM102L	Circuit 1.8m length w/22mm conn + 1.0m + 2Lbag	10
22P2422FM102L	Circuit 2.4m length w/22mm conn + 1.0m + 2Lbag	10
22P1822CGS	Complete Kit 1.8m w/22mm conn + 1.0m + 2Lbag + Gas Sampling	10
22P2422CGS	Complete Kit 2.4m w/22mm conn + 1.0m + 2Lbag + Gas Sampling	10

**CONFIGURE**  
 Custom designs available. Ask for our design program on CD Design and be quoted immediately on your own pc!

+44 (0) 1258 471 770  
 +44 (0) 1258 471 772

Tel Fax

Meditech Systems Limited  
 Unit 3 Richmar  
 Butt's Pond Ind.Estate  
 Sturminster Newton  
 Dorset DT10 1AZ

meditech  
 systems limited

## SWIVEL 'Y' PIECE CIRCUITS

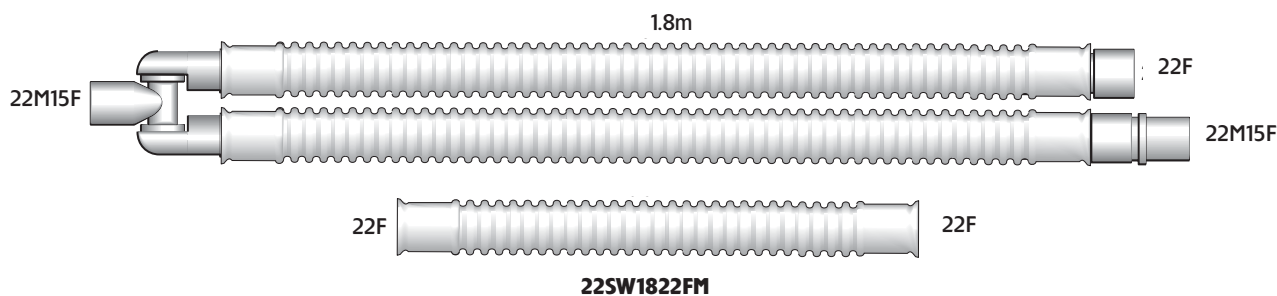

## CODE

## DESCRIPTION

## BOX QTY

CODE	DESCRIPTION	BOX QTY
22SW1622FF	Circuit 1.6m Length Basic Design	10
22SW1822FF	Circuit 1.8m Length Basic Design	10
22SW2422FF	Circuit 2.4m Length Basic Design	10
22SW3022FF	Circuit 3.0m Length Basic Design	10
22SW1622FM	Circuit 1.6m Length w/22mm connector	10
22SW1822FM	Circuit 1.8m Length w/22mm connector	10
22SW1622FM10	Circuit 1.6m Length w/22mm conn+ 1.0m limb	10
22SW1822FM10	Circuit 1.6m Length w/22mm conn+ 1.0m limb	10
22SW1622FM102L	Circuit 1.6m length w/22mm conn + 1.0m + 2Lbag	10
22SW1822FM102L	Circuit 1.6m length w/22mm conn + 1.0m + 2Lbag	10

## CPCP CIRCUITS

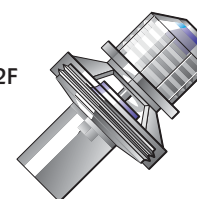
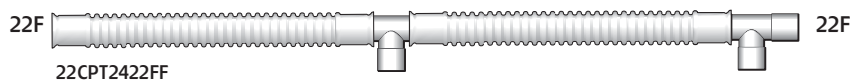
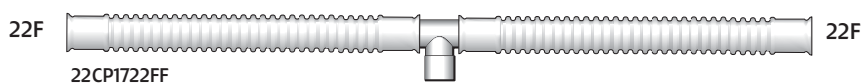
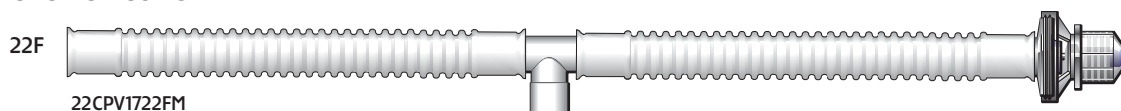

**PEEP VALVES**  
2250-0099

## CODE

## DESCRIPTION

## BOX QTY

CODE	DESCRIPTION	BOX QTY
22CPV1722FM	Circuit 1.75m with Peep Valve, Tpcce 22Mx15F	20
22CP1722FF	Circuit 1.75m, No valve, Tpcce 22Mx15F	20
22CPT2422FF	Circuit 2.4m, Tpcce 22Fx 22M15F + Tpcce 22Mx15F	20
2250-0099	Peep valve 0-20cm (fitting 22OD x 15ID) disposable	20
22RE-0099	Peep valve 0-20cm (fitting 22OD x 15ID) reusable	20
2250-0093	Peep valve 0-20cm (fitting 30ID) disposable	20
22RE-0093	Peep valve 0-20cm (fitting 30ID) disposable	20

## CONFIGURE

Custom designs available. Ask for our design program on CD Design and be quoted immediately on your own pdf.

medi  
tech  
Systems limited

Meditech Systems Limited  
Unit 3 Richmond  
Butt's Pond Industrial Estate  
Sturminster Newton  
Dorset DT10 1AZ

Tel

+44 (0) 1258 471 770

Fax

+44 (0) 1258 471 772

**ALL  
COMPONENTS  
LATEX  
FREE**

**06 >>**

Ventilator Circuits

**BAIN STYLE COAXIL CIRCUITS**

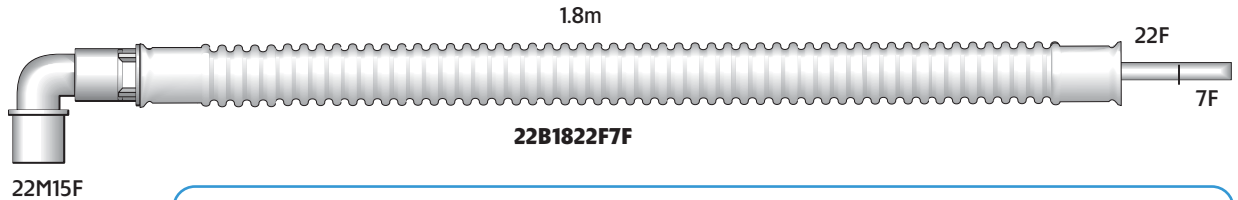

CODE	DESCRIPTION	BOX QTY
22B1622F7F	Circuit 1.6m Length Basic Design (for connection to reusable valve)	15
22B1822F7F	Circuit 1.8m Length Basic Design (for connection to reusable valve)	15
22B2422F7F	Circuit 2.4m Length Basic Design (for connection to reusable valve)	15
22B3022F7F	Circuit 3.0m Length Basic Design (for connection to reusable valve)	15
22B4422F7F	Circuit 4.4m Length Basic Design (for connection to reusable valve)	15

**JACKSON REES CIRCUITS 22JR0322**

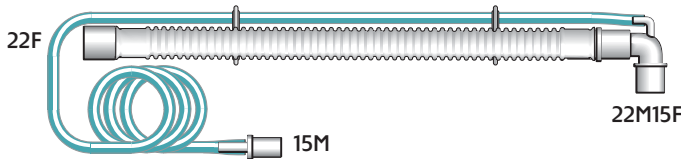

**AYRES T PIECE CIRCUITS**

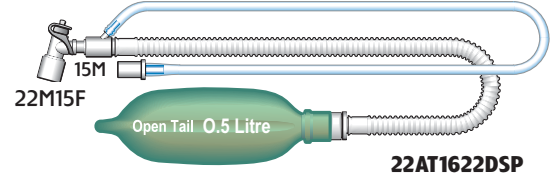

**MAPLESON D CIRCUITS**

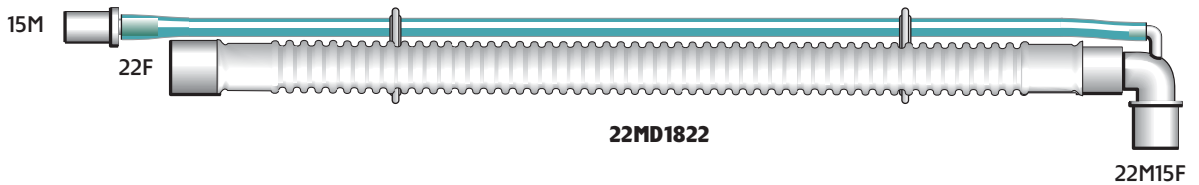

CODE	DESCRIPTION	BOX QTY
22JR0322	JACKSON REES Circuit 0.3m Length Basic Design	20
22JR1622	JACKSON REES Circuit 0.3m Length + 0.5 Litre Bag	20
22JR03221L	JACKSON REES Circuit 0.3m Length + 1 litre Bag	20
22JR03222L	JACKSON REES Circuit 0.3m Length + 2 litre Bag	20
22AT1622DS	AYRES T Circuit 1.6M fresh gas line + 0.5L Bag w/Double swivel elbow	20
22AT1622DSP	AYRES T Circuit 1.6M fresh gas line + 0.5L Bag w/Double swivel elbow ported	20
22AT1622GS	ATRES T Circuit 1.6M fresh gas line,GS Elbow + 0.5L Bag	20
22MD1622	MAPLESON D Circuit 1.6M length	20
22MD1822	MAPLESON D Circuit 1.8M length	20
22MD2422	MAPLESON D Circuit 2.4M length	20
22MD3022	MAPLESON D Circuit 3.0M length	20

Tel +44 (0) 1258 471 770  
Fax +44 (0) 1258 471 772

Meditech Systems Limited  
Unit 3 Richmar  
Butt's Pond Ind.Estate  
Sturminster Newton  
Dorset DT10 1AZ

**meditech**  
systems limited

FOR ALL ORDERS CALL DIRECT **0700 - 4 - MEDITECH**

**ALL  
COMPONENTS  
LATEX  
FREE**

**FLEXIBLE TUBING**

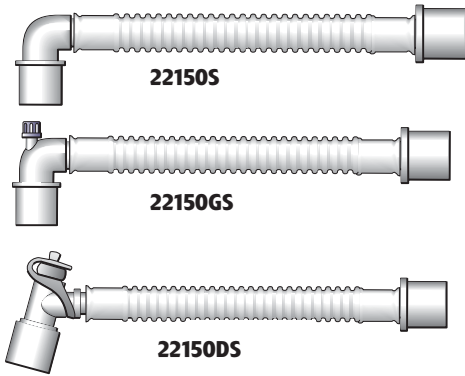

**SMOOTHBORE TUBING**

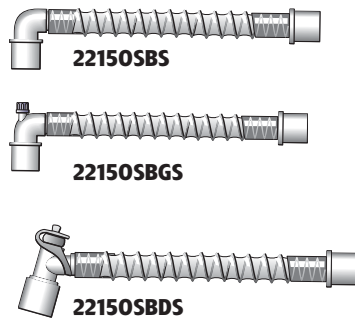

**EXTENDIBLE TUBING**

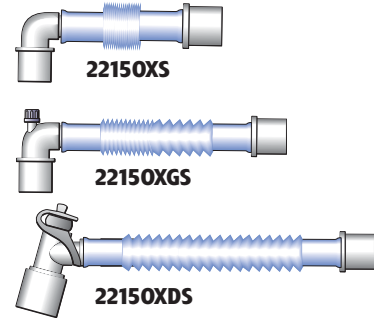

**LATEX FREE RE-BREATHING BAGS**

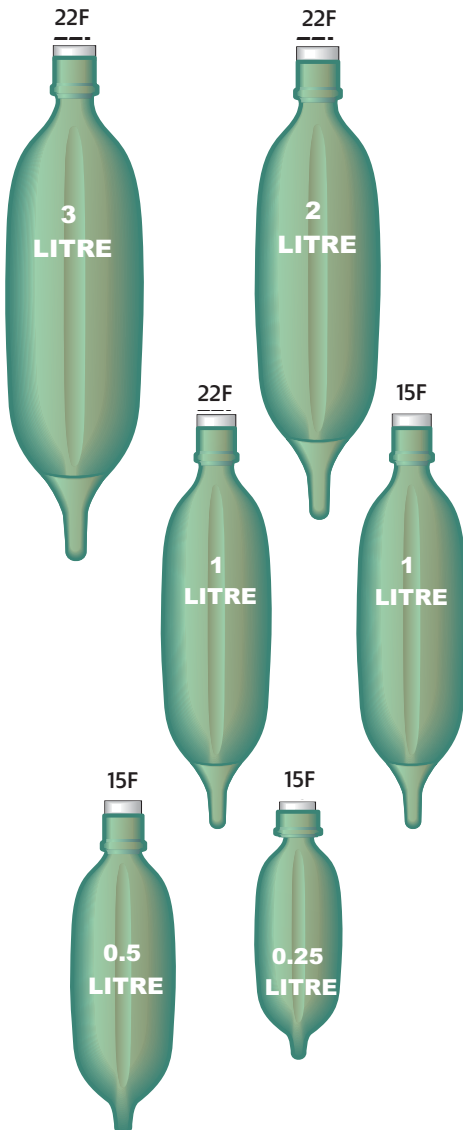

**FLEXIBLE TUBING**

CODE	DESCRIPTION	BOX QTY
22150S	Disposable Catheter Mount Standard Elbow	50
22150GS	Disposable Catheter Mount Gas Sampling Elbow	50
22150DS	Disposable Catheter Mount Double Swivel Elbow	50
22150	Disposable Catheter Mount Straight connector	50

**SMOOTHBORE TUBING**

CODE	DESCRIPTION	BOX QTY
22SB150S	Disposable Smoothbore Catheter Mount Standard Elbow	50
22SB150GS	Disposable Smoothbore Catheter Mount Gas Sampling Elbow	50
22SB150DS	Disposable Smoothbore Catheter Mount Double Swivel Elbow	50
22SB150	Disposable Smoothbore Catheter Mount Straight connector	50

**EXTENDIBLE TUBING**

CODE	DESCRIPTION	BOX QTY
22150XS	Disposable Extendible Catheter Mount Standard Elbow	50
22150XGS	Disposable Extendible Catheter Mount Gas Sampling Elbow	50
22150XDS	Disposable Extendible Catheter Mount Double Swivel Elbow	50
22150X	Disposable Extendible Catheter Mount Straight connector	50

**RESERVOIR BAGS**

CODE	DESCRIPTION	BOX QTY
221025	0.25 Litre Re-breathing Bag with 15mm ID connector	20
221050	0.5 Litre Re-breathing Bag with 15mm ID connector	20
221115	1 Litre Re-breathing Bag with 15mm ID connector	20
221100	1 Litre Re-breathing Bag with 22mm ID connector	20
221200	2 Litre Re-breathing Bag with 22mm ID connector	20
221300	3 Litre Re-breathing Bag with 22mm ID connector	20

**ALL  
COMPONENTS  
LATEX  
FREE**

**08 >>**

Deluxe Bain circuits

**DELUXE BAIN CIRCUITS**

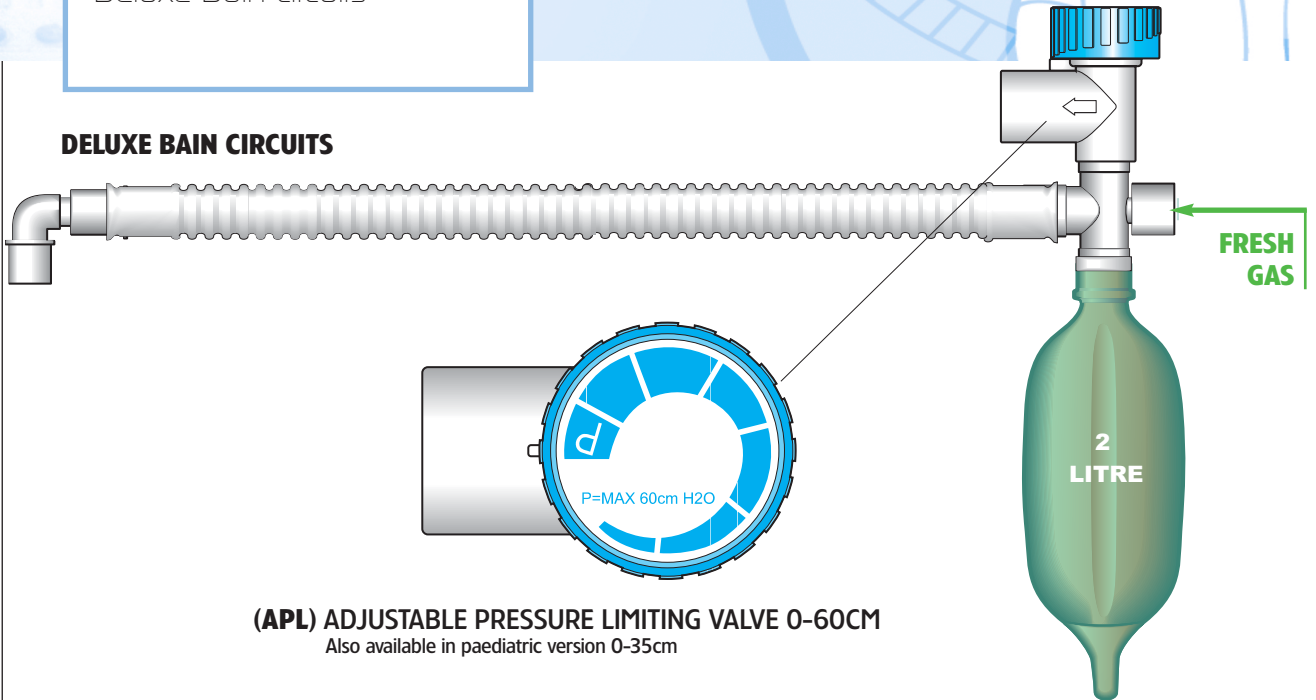

**(APL) ADJUSTABLE PRESSURE LIMITING VALVE 0-60CM**  
Also available in paediatric version 0-35cm

CODE	DESCRIPTION	BOX QTY
22B1622APL	Deluxe Bain Circuit 1.6, w/APL valve (60cm) & 2 Litre Bag	10
22B1822APL	Deluxe Bain Circuit 1.8, w/APL valve (60cm) & 2 Litre Bag	10
22B2422APL	Deluxe Bain Circuit 2.4, w/APL valve (60cm) & 2 Litre Bag	10
22B4822APL	Deluxe Bain Circuit 4.8, w/APL valve (60cm) & 2 Litre Bag	10

**MAPLESON C -ADULT BAGGING SYSTEM**

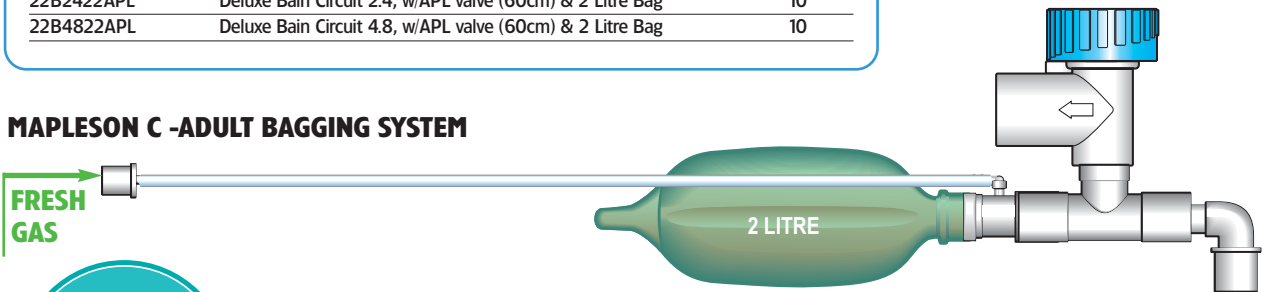

CODE	DESCRIPTION	BOX QTY
22MC1822APL	Mapleson C Adult Bagging System, w/APL & 2 Litre Bag	20

**CONFIGURE**

Custom designs available. Ask for our design program on CD Design and be quoted immediately on your own pc!

**NEW  
user friendly  
ORDERING  
SOFTWARE**

**CONFIGURE CD PROGRAM**

Developed by ICAN Software Ltd

Configure is available to all Meditech dealers along with a full comprehensive product offering in anaesthesia and respiratory products. contact customer service for your installation CD:

**T. +44(0)1258 471 770 F. +44(0)1258 471 772**

Tel +44 (0) 1258 471 770  
Fax +44 (0) 1258 471 772

Meditech Systems Limited  
Unit 3 Richmar  
Butt's Pond Ind.Estate  
Sturminster Newton  
Dorset DT10 1AZ

**meditech**  
systems limited

FOR ALL ORDERS CALL DIRECT **0700 - 4 - MEDITECH**

**ALL  
COMPONENTS  
LATEX  
FREE**

**09 >>**

Deluxe Bain circuits

**MAPLESON A - MAGILL SYSTEM**

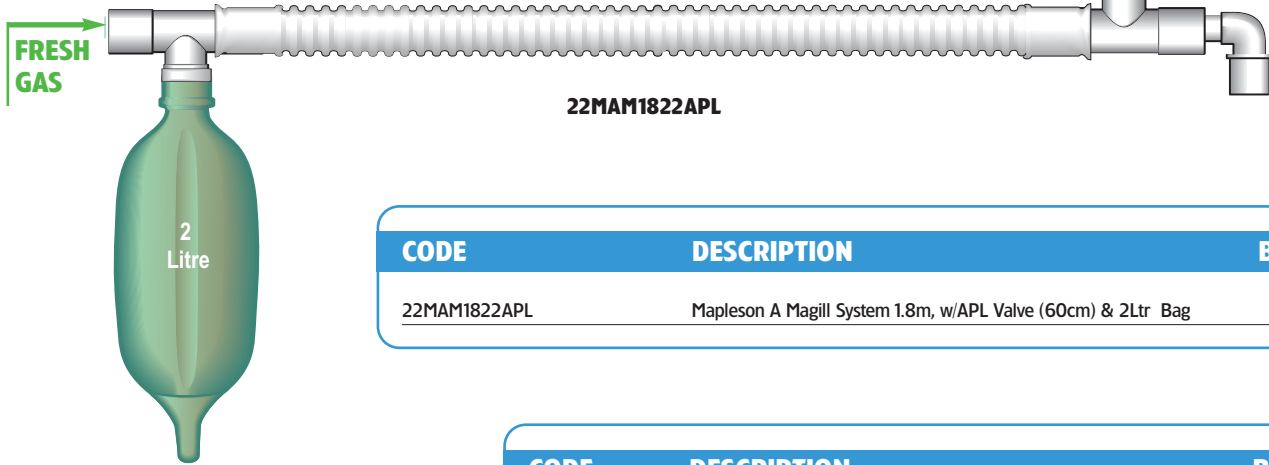

CODE	DESCRIPTION	BOX QTY
22MAM1822APL	Mapleson A Magill System 1.8m, w/APL Valve (60cm) & 2Ltr Bag	10

CODE	DESCRIPTION	BOX QTY
22MAL1822APL	Mapleson A Parallel Lack System 1.8m, w/APL Valve (60cm) & 2Ltr Bag	10

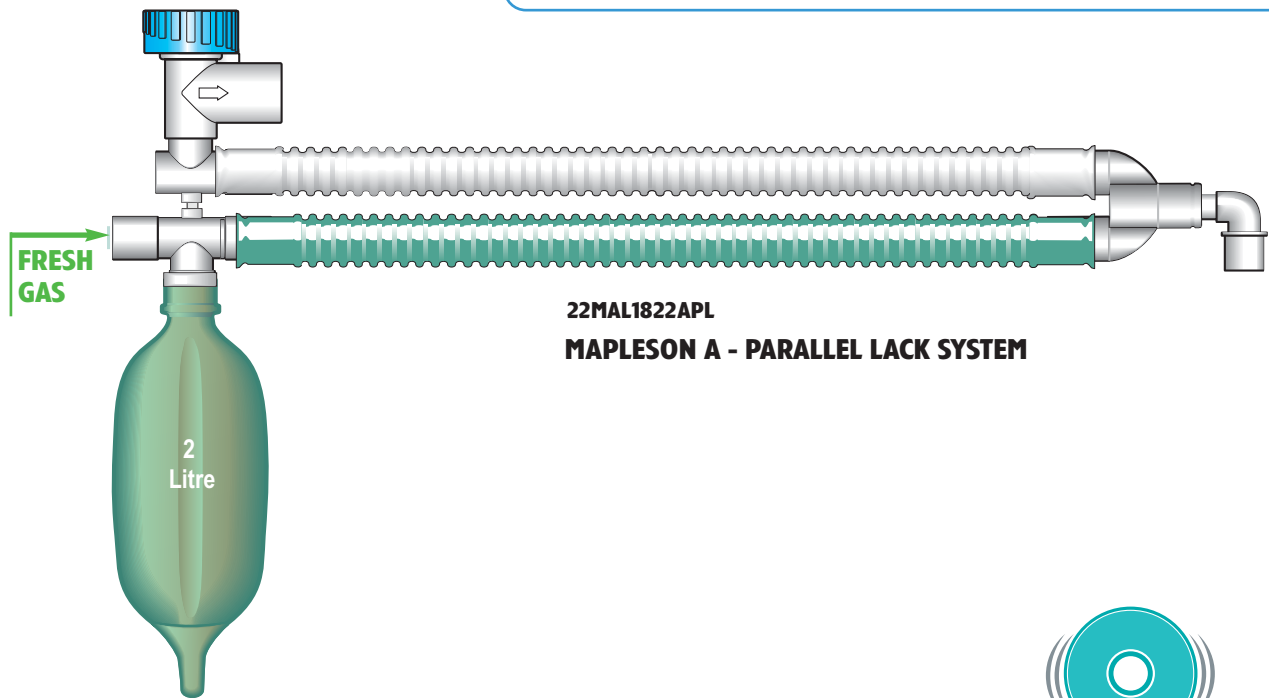

**22MAL1822APL  
MAPLESON A - PARALLEL LACK SYSTEM**

**CONFIGURE CD PROGRAM**

Developed by ICAN Software Ltd

Configure is available to all Meditech dealers along with a full comprehensive product offering in anaesthesia and respiratory products. contact customer service for your installation CD:

**T. +44(0)1258 471 770 F. +44(0)1258 471 772**



**CONFIGURE**

Custom designs available. Ask for our design program on CD Design and be quoted immediately on your own pc!

**NEW  
user friendly  
ORDERING  
SOFTWARE**

meditech  
Systems Limited

Meditech Systems Limited  
Unit 3 Richmond  
Butt's Pond Ind Estate  
Sturminster Newton  
Dorset DT10 1AZ

Tel +44 (0) 1258 471 770  
Fax +44 (0) 1258 471 772

FOR ALL ORDERS CALL DIRECT **0700 - 4 - MEDITECH**

**ALL  
COMPONENTS  
LATEX  
FREE**

**10 >>**

Intensive care circuits

**WATER TRAP CIRCUITS**

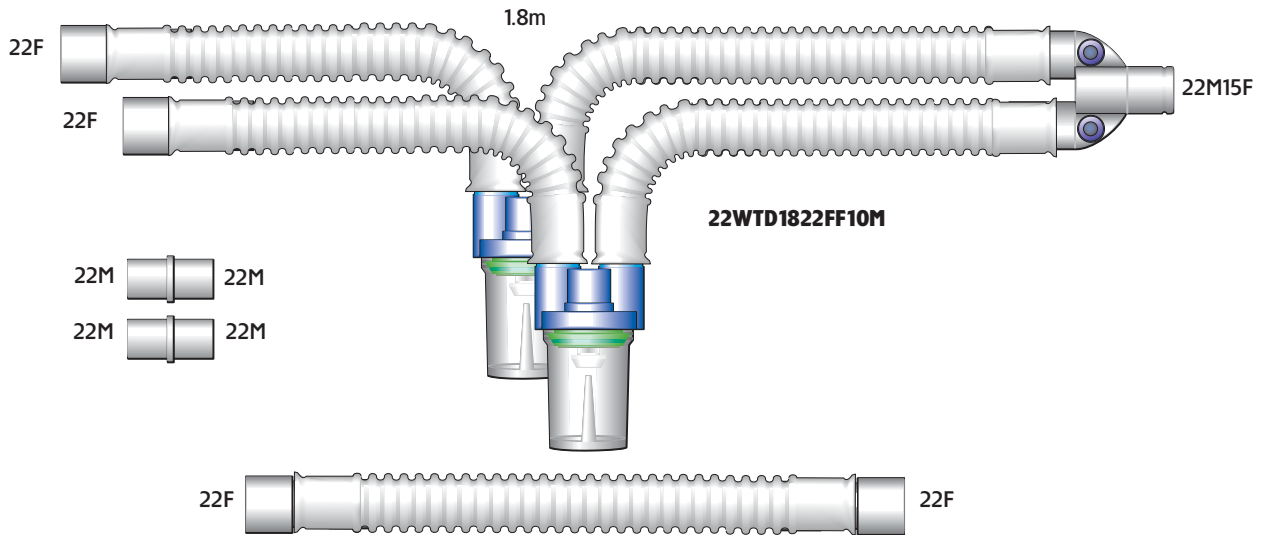

CODE	DESCRIPTION	BOX QTY
22WT1822FF10M	Ported Y Circuit 1.6m, 2 x Water Traps, 1.0m limb, 2 x MM	10
22WTD1822FF10M	Ported Y Circuit 1.6m Detachable, 2 x Water Traps, 1.0m Limb, 2 x MM	10
22WT1822FF10MD	Ported Y Circuit 1.6m, 2 x Water Traps, 1.0m Limb, 2 x MM, (Drager)	10
22WT1822FF10MS	Ported Y Circuit 1.6m, 2 x W/ Traps, 1.0m limb, 2 x MM, Soft Connectors	10

**VOLUME VENTILATOR CIRCUITS**

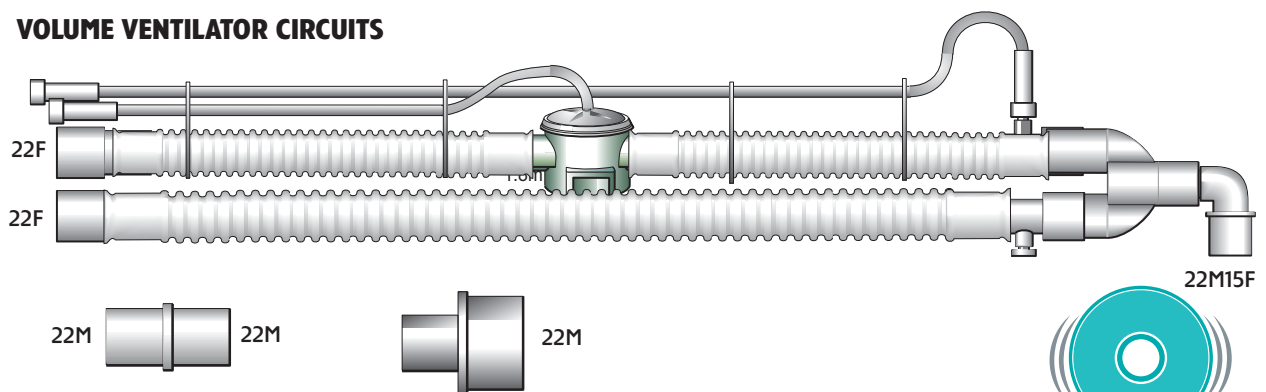

CODE	DESCRIPTION	BOX QTY
223281	Universal Volume Ventilator Circuit (External Exhalation Valve) (Bourns, Bear & Bennet MA/ Series)	10

**CONFIGURE**

Custom designs available. Ask for our design program on CD Design and be quoted immediately on your own pc!

Tel +44 (0) 1258 471 770  
Fax +44 (0) 1258 471 772

Meditech Systems Limited  
Unit 3 Richmar  
Butt's Pond Ind. Estate  
Sturminster Newton  
Dorset DT10 1AZ



FOR ALL ORDERS CALL DIRECT **0700 - 4 - MEDITECH**

**ALL  
COMPONENTS  
LATEX  
FREE**

**11 >>**

Intensive care circuits

**PORTED 'Y' PIECE CIRCUITS**

1.8m

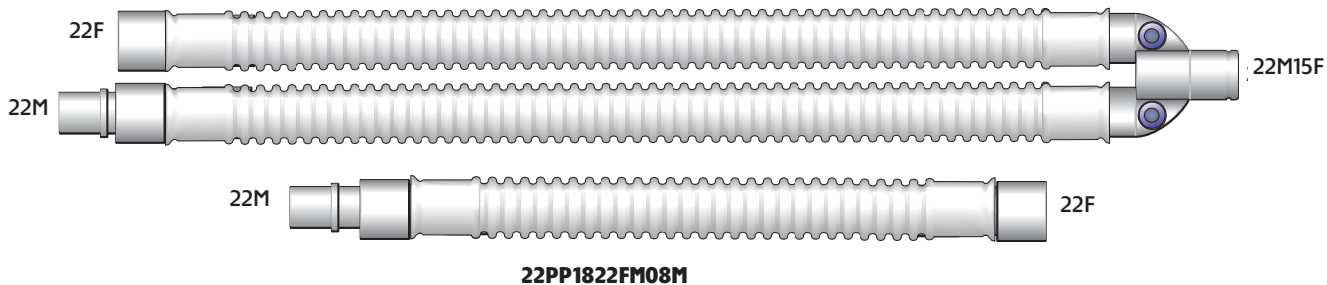

CODE	DESCRIPTION	BOX QTY
22PP1622FM10M	Ported Y Circuit 1.6m Length w/ 2 x 22mm conns + 1.0m limb	10
22PP1822FM10M	Ported Y Circuit 1.8m Length w/ 2 x 22mm conns + 1.0m limb	10
22PP2422FM10M	Ported Y Circuit 2.4m Length w/ 2 x 22mm conns + 1.0m limb	10
22PP3022FM10M	Ported Y Circuit 3.0m Length w/ 2 x 22mm conns + 1.0m limb	10

**HEATED WIRE CIRCUITS**

1.8m

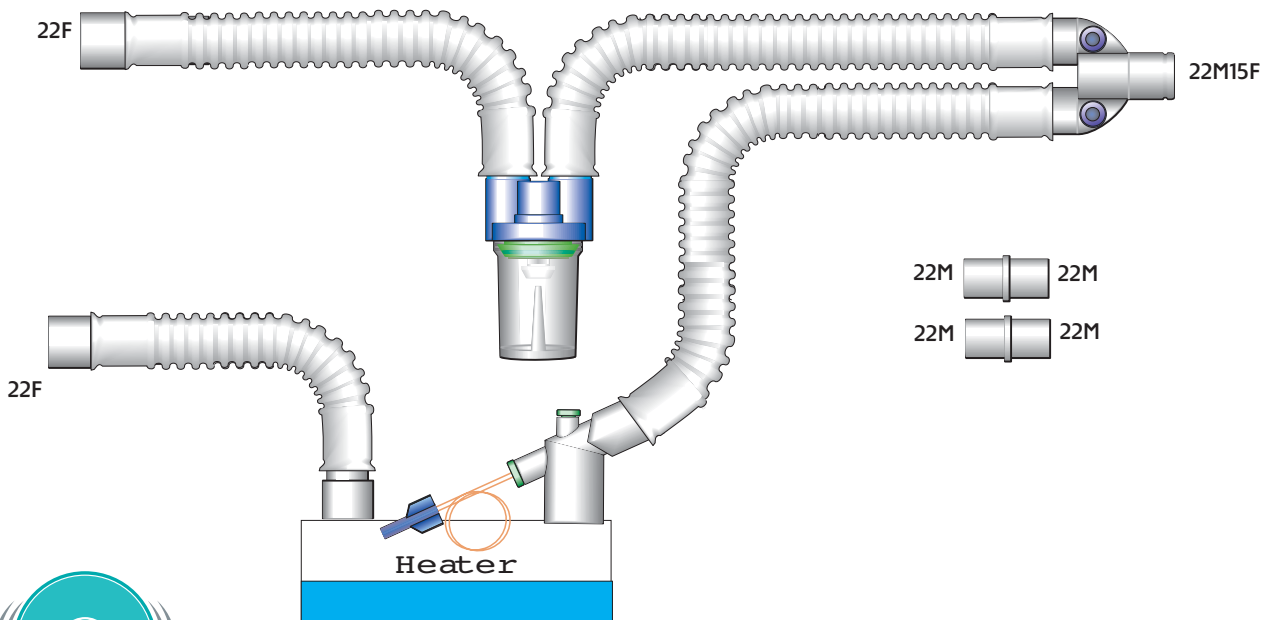

CODE	DESCRIPTION	BOX QTY
<i>Circuits for use with F&amp;P MR850 &amp; MR730</i>		
22HW1622FF10M	Single Heated Wire Circuit 1.6m ,W/Trap, 1.0m limb,	10
22HW21622FF10M	Dual Heated Wire Circuit 1.6m, 1.0 Limb,	10
<i>Circuits for use with F&amp;P MR500,600,730,concha 4 &amp; vital Signs SCT3000</i>		
22HW1622FF10MU	Single Heated Wire Circuit 1.6m ,W/Trap, 1.0m limb,	10
22HW21622FF10MU	Dual Heated Wire Circuit 1.6m, 1.0m Limb,	10



Custom designs available. Ask for our design program on CD Design and be quoted immediately on your own pc!

meditech  
systems limited

Meditech Systems Limited  
Unit 3 Richmond  
Butt's Pond Ind Estate  
Sturminster Newton  
Dorset DT10 1AZ

Tel +44 (0) 1258 471 770  
Fax +44 (0) 1258 471 772

**ALL  
COMPONENTS  
LATEX  
FREE**

**12 >>**

Smoothbore Circuits

**SMOOTHBORE CIRCUITS**

22SB1622FF

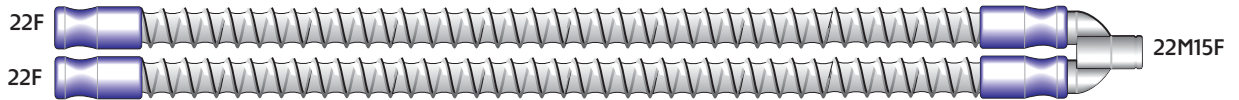

CODE	DESCRIPTION	BOX QTY
22SB1622FF	Adult Smoothbore Circuit 1.6m	10
22SB1622FM10	Adult Smoothbore Circuit 1.6m with 1.0m limb	10
22SB1615FF	Paediatric Smoothbore Circuit 1.6m	10

**SMOOTHBORE  
WATER TRAP  
CIRCUITS**

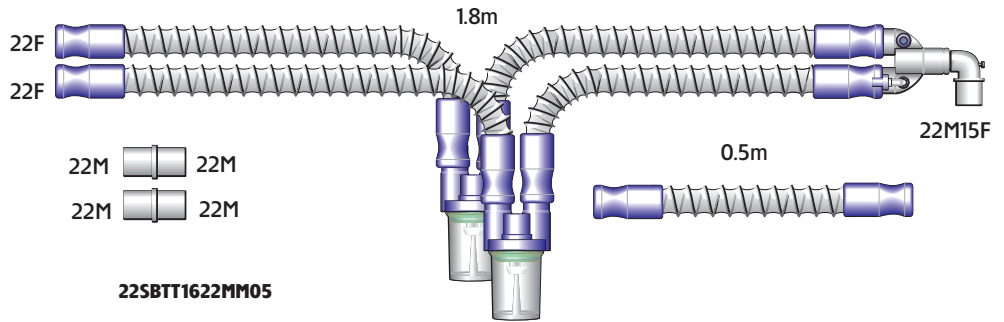

22SBTT1622MM05

CODE	DESCRIPTION	BOX QTY
22SBT1822MM	Adult Smoothbore Circuit ,One water Trap,	10
22SBTT1822MM	Adult Smoothbore Circuit ,Two water Traps	10
22SBTT1822MM05	Adult Smoothbore Circuit ,Two water Traps, 0.5m Limb	10

**SMOOTHBORE HEATED  
WIRE CIRCUITS**

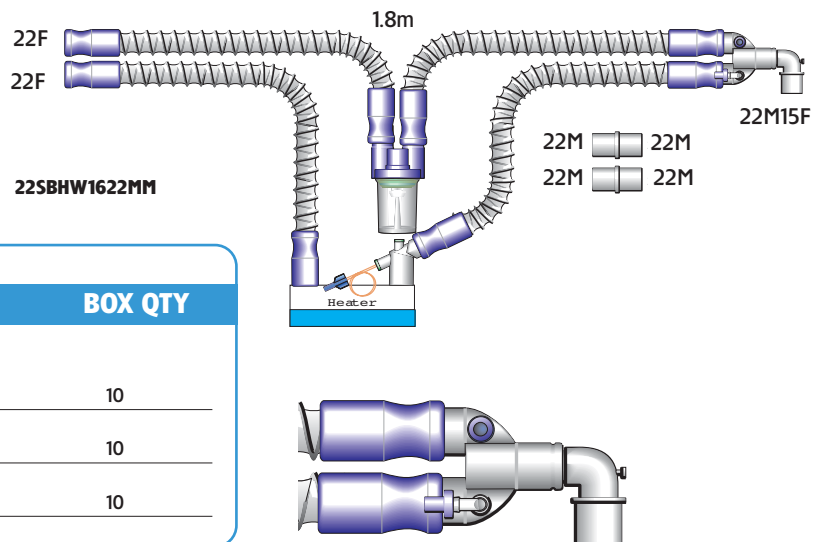

22SBHW1622MM

CODE	DESCRIPTION	BOX QTY
22SBHW1822MM	Single Heated Wire Circuit with 0.5m Limb SMOOTHBORE	10
22SBHWW1822MM	Dual heated Wire Circuit with 0.5m Limb SMOOTHBORE	10
22SBHW1822MMU	Single Heated Wire Circuit with 0.5m limb	10

Tel +44 (0) 1258 471 770  
Fax +44 (0) 1258 471 772

Meditech Systems Limited  
Unit 3 Richmar  
Butt's Pond Ind.Estate  
Sturminster Newton  
Dorset DT10 1AZ

**meditech**  
systems limited

FOR ALL ORDERS CALL DIRECT **0700 - 4 - MEDITECH**

**ALL  
COMPONENTS  
LATEX  
FREE**

**13 >>**

Extendible Circuits

**EXTENDIBLE TUBING CIRCUITS**

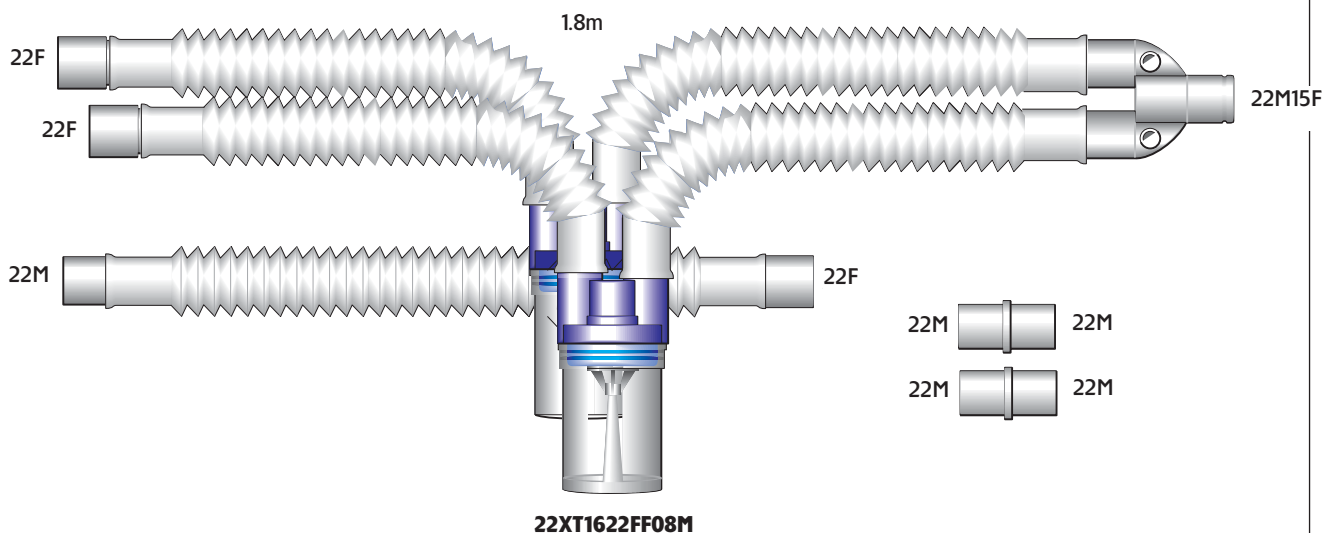

CODE	DESCRIPTION	BOX QTY
22XT1822FF10M	Ported Y Circuit 1.6m, 2 x Water Traps, 1.0m limb, 2 x MM	10
22XTD1822FF10M	Ported Y Circuit 1.6m Detachable ,2 x Water Traps, 1.0m Limb, 2 x MM	10
22XT1822FF10MD	Ported Y Circuit 1.6m, 2 x Water Traps, 1.0m Limb, 2 x MM, (Drager)	10
22XT1822FF10MS	Ported Y Circuit 1.6m, 2 x W/ Traps, 1.0m limb, 2 x MM,Soft Connectors	10

**EXTENDIBLE CIRCUITS**

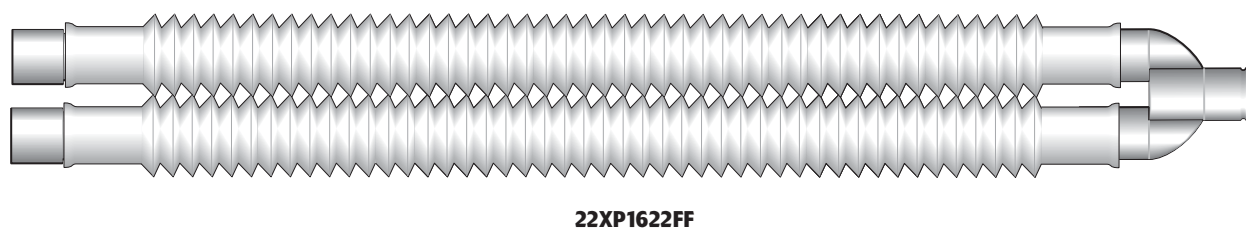

CODE	DESCRIPTION	BOX QTY
22XP1822FF	Adult 1.6m Extendible Circuit	20
22XP2022FF	Adult 2.0m extendible Circuit	20
22XP1822FF102L	Adult 1.6m Extendible Circuit, 1.0m extra Limb & 2 Litre Bag	20
22XP2022FF102L	Adult 2.0m extendible Circuit, 1.0m extra Limb & 2 Litre Bag	20
22XP1822FF103L	Adult 1.6m Extendible Circuit, 1.0m extra Limb & 3 Litre Bag	20
22XP2022FF103L	Adult 2.0m extendible Circuit, 1.0m extra Limb & 3 Litre Bag	20

\* lengths quoted are tube fully extended

meditech  
systems limited

Meditech Systems Limited  
Unit 3 Richmond  
Butt's Pond Industrial Estate  
Sturminster Newton  
Dorset DT10 1AZ

Tel +44 (0) 1258 471 770  
Fax +44 (0) 1258 471 772

FOR ALL ORDERS CALL DIRECT **0700 - 4 - MEDITECH**

**ALL COMPONENTS LATEX FREE**

**14 >>**

Bacterial/Viral filters and HME's

**HEPA FILTER 32501**



22M15F

22F15M

22M15F

**32501M**

22F15M

22M15F

**32501HM**

22F15M

CODE	DESCRIPTION	BOX QTY
32501	HEPA filter standard 99.9999% efficiency bacterial/viral	50
32501M	HEPA filter mini size 99.9999% efficiency bacterial/viral	50
32501HM	HEPA filter mini size + HME 99.9999% efficiency bacterial/viral	50

**ELECTROSTATIC FILTERS AND HME'S**

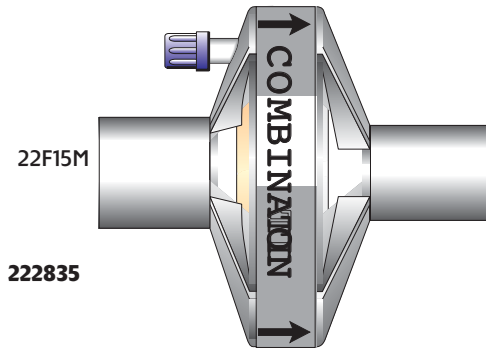

22F15M

22M15F

**222835**

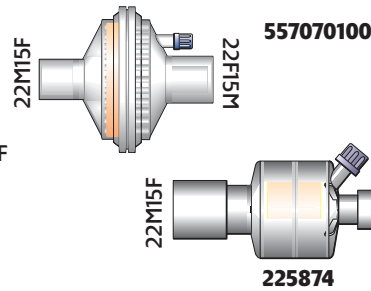

22M15F

22F15M

**557070100**

22M15F

15M

**225874**

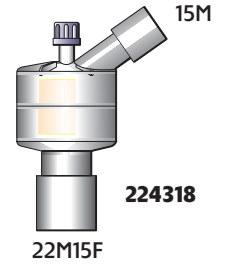

15M

**224318**

22M15F

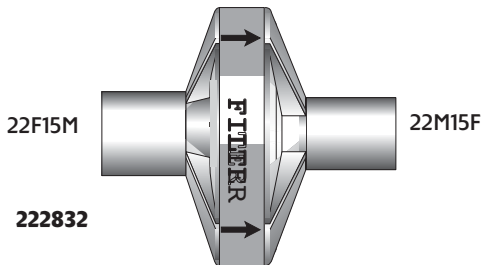

22F15M

22M15F

**222832**

CODE	DESCRIPTION	BOX QTY
222832	Standard filter electrostatic 99.9999% efficiency bacterial/viral	50
222835	Combination filter and HME 99.9999% efficiency bacterial/viral	50
222833	Mini combination filter and HME 99.9999% efficiency bacterial/viral (slimline)	50
224318	Mini combination filter and HME 99.9999% efficiency bacterial/viral (straight)	50
225874	Mini combination filter and HME elbow 99.9999% efficiency bacterial/viral	50

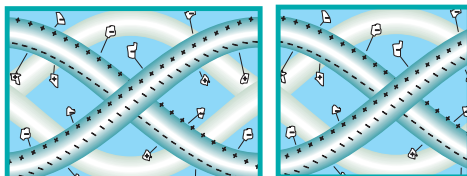

**ELECTROSTATIC FILTER MEDIA**

Electrostatically charged fibres attract positive and negatively charged particles. Filtration efficiency 99.9999%

Tel +44 (0) 1258 471 770  
Fax +44 (0) 1258 471 772

Meditech Systems Limited  
Unit 3 Richmar  
Butt's Pond Ind.Estate  
Sturminster Newton  
Dorset DT10 1AZ

meditech  
systems limited

FOR ALL ORDERS CALL DIRECT **0700 - 4 - MEDITECH**

**ALL  
COMPONENTS  
LATEX  
FREE**

**15 >>**

Anaesthesia Masks

**ANAESTHESIA MASKS SCENTED AND UNSCENTED**

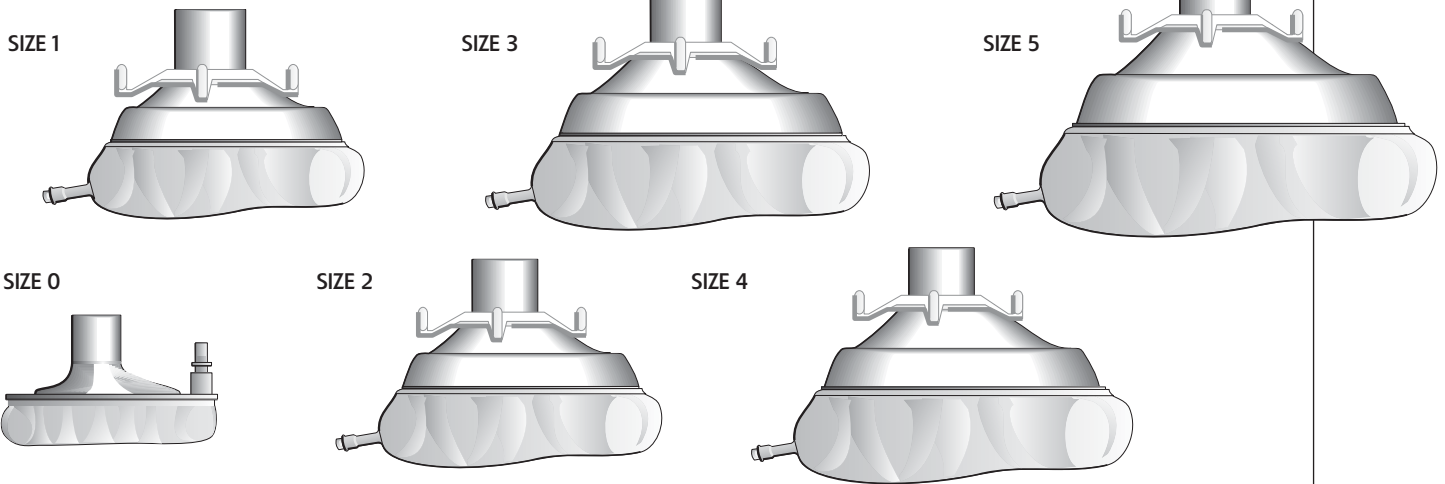

STANDARD		
CODE	DESCRIPTION	BOX QTY
22005	Disposable Anaesthesia Mask w/valve Large Adult 5	50
22004	Disposable Anaesthesia Mask w/valve Med Adult 4	50
22003	Disposable Anaesthesia Mask w/valve Small Adult 3	50
22002	Disposable Anaesthesia Mask w/valve Child 2	50
22001	Disposable Anaesthesia Mask w/valve Infant 1	50
22001	Disposable Anaesthesia Mask w/valve Neonate 0	50

SCENTED		
CODE	DESCRIPTION	BOX QTY
22015	Disposable Anaesthesia Mask w/valve Large Adult 5	50
22014	Disposable Anaesthesia Mask w/valve Med Adult 4	50
22013	Disposable Anaesthesia Mask w/valve Small Adult 3	50
22012	Disposable Anaesthesia Mask w/valve Child 2	50
22011	Disposable Anaesthesia Mask w/valve Infant 1	50
22010	Disposable Anaesthesia Mask w/valve Neonate 0	50

**GAS SAMPLING LINES**

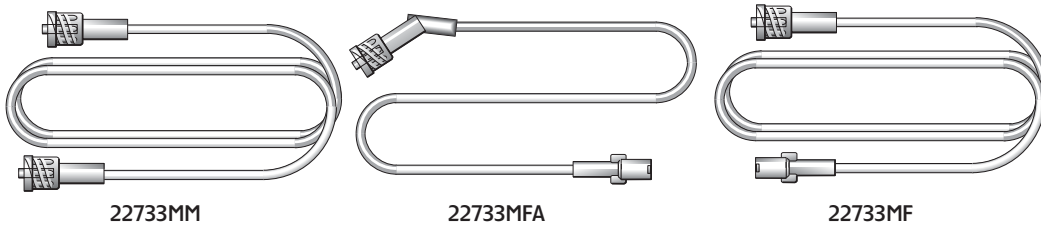

CODE	DESCRIPTION	BOX QTY
22733MM	Gas Sampling Line 3 metre Male to Male Luer	100
22735MM	Gas Sampling Line 5 metre Male to Male Luer	100
22733MF	Gas Sampling Line 3 metre Male to Female Luer	100
22735MF	Gas Sampling Line 5 metre Male to Female Luer	100
22733MFA	Gas Sampling Line 3 metre Male to Female Luer Angled	100
22733MMA	Gas Sampling Line 3 metre Male to Male Luer Angled	100



Custom designs available. Ask for our design program on CD Design and be quoted immediately on your own pc!

meditech  
Systems Limited

Meditech Systems Limited  
Unit 3 Richmond  
Butt's Pond Industrial Estate  
Sturminster Newton  
Dorset DT10 1AZ

Tel +44 (0) 1258 471 770  
Fax +44 (0) 1258 471 772

**ALL  
COMPONENTS  
LATEX  
FREE**

16 >>

Oxygen Therapy



221426

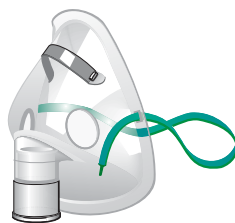

221476



221479

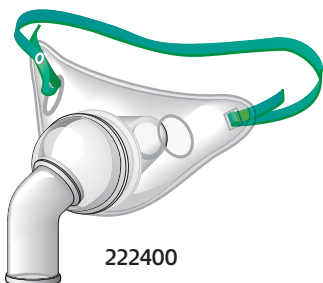

222400



222470



221490

CODE	DESCRIPTION	BOX QTY
221426	Adult Aerosol Mask	50
221476	Paediatric Aerosol Mask	50
221479	Infant Aerosol Mask	50
221490	Adult Face Tent	50
222400	Adult Tracheotomy Mask	50
222470	Paediatric Tracheotomy Mask	50

CODE	DESCRIPTION	BOX QTY
225022450	Corrugated Aerosol Tubing 22mm x 50m roll (Cuffed 450mm)	1
225022150	Corrugated Aerosol Tubing 22mm x 50m roll (Cuffed 150mm)	1
2250221000	Corrugated Aerosol Tubing 22mm x 50m roll (Cuffed 1000mm)	1
221622	Corrugated Aerosol Tubing 22mm x 1.6m cut length	50
221822	Corrugated Aerosol Tubing 22mm x 1.8m cut length	50
225015450	Corrugated Aerosol Tubing 15mm x 50m roll (Cuffed 450mm)	1
225015150	Corrugated Aerosol Tubing 15mm x 50m roll (Cuffed 150mm)	1
2250151000	Corrugated Aerosol Tubing 15mm x 50m roll (Cuffed 1000mm)	1

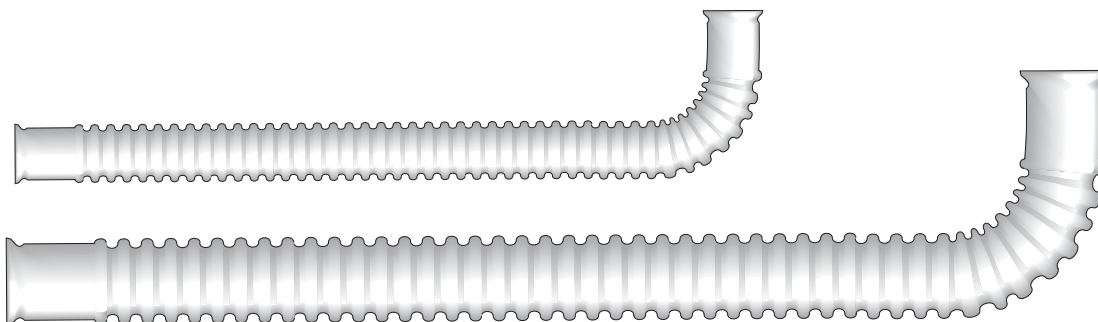

Tel +44 (0) 1258 471 770  
Fax +44 (0) 1258 471 772

Meditech Systems Limited  
Unit 3 Richmar  
Butt's Pond Ind.Estate  
Sturminster Newton  
Dorset DT10 1AZ

**meditech**  
systems limited

FOR ALL ORDERS CALL DIRECT **0700 - 4 - MEDITECH**

**ALL  
COMPONENTS  
LATEX  
FREE**

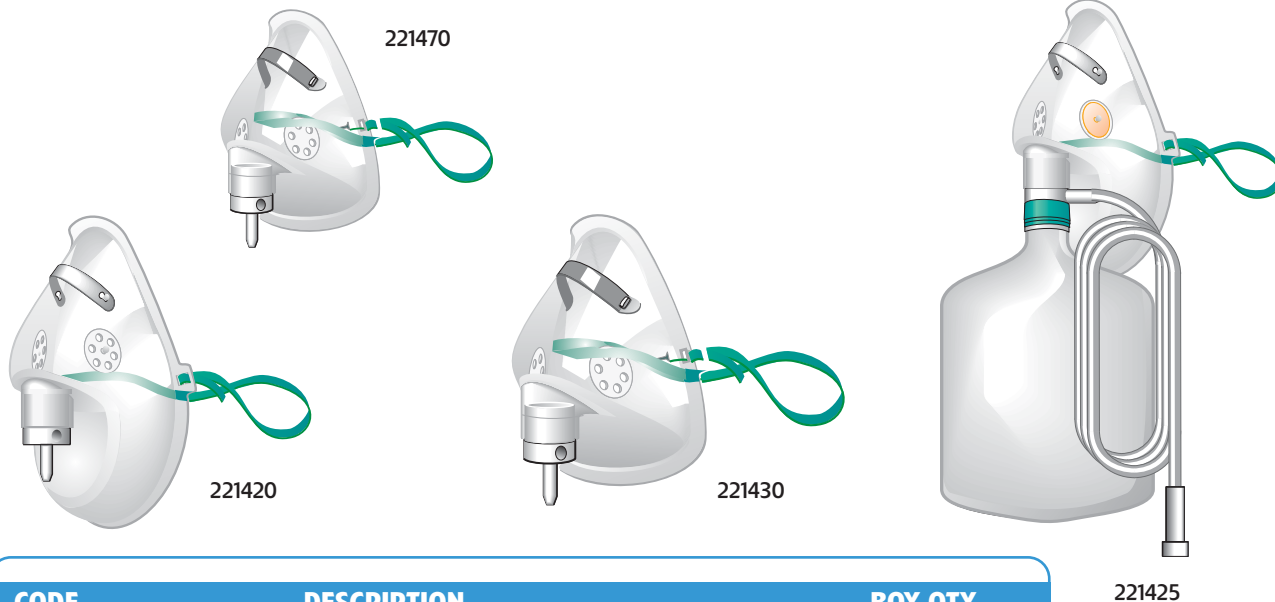

CODE	DESCRIPTION	BOX QTY
221420	Adult Oxygen Mask	50
221470	Paediatric Oxygen Mask	50
221430	Adult Short Style Oxygen Mask	50
221480	Infant Oxygen Mask	50
221423	Adult Hi-Concentration Mask Non-Rebreathing	50
221425	Adult Hi-Concentration Mask Non-Rebreathing w/tubing	50

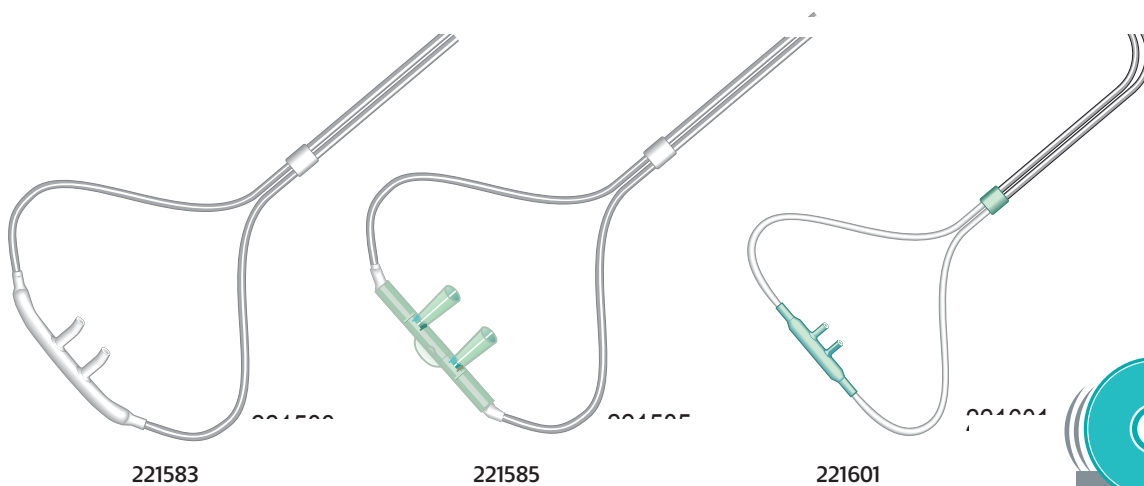

CODE	DESCRIPTION	BOX QTY
221585	Adult Nasal Cannula with Curved Flared Tips	50
221583	Adult Nasal Cannula with SOFTEX Tips	50
221582	Adult Nasal Cannula with straight Tips	50
221601	Child Nasal Cannula	50
221602	Infant Nasal Cannula	50



**CONFIGURE**

Custom designs available. Ask for our design program on CD Design and be quoted immediately on your own pc!

meditech  
systems limited

Meditech Systems Limited  
Unit 3 Richmond  
Butt's Pond Industrial Estate  
Sturminster Newton  
Dorset DT10 1AZ

Tel +44 (0) 1258 471 770  
Fax +44 (0) 1258 471 772

**ALL  
COMPONENTS  
LATEX  
FREE**

**18 >>**

Venturi systems

**VENTURI DILUTER JETS**

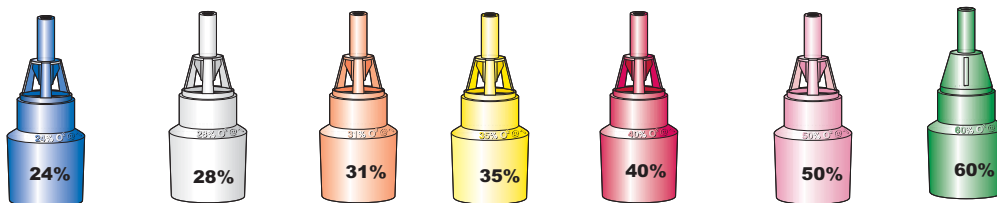

CODE	DESCRIPTION	BOX QTY
221024	Venturi Diluter Jet (Fixed O2 Percentage) 24% Blue	100
221028	Venturi Diluter Jet (Fixed O2 Percentage) 28% White	100
221031	Venturi Diluter Jet (Fixed O2 Percentage) 31% Orange	100
221035	Venturi Diluter Jet (Fixed O2 Percentage) 35% Yellow	100
221040	Venturi Diluter Jet (Fixed O2 Percentage) 40% Red	100
221050	Venturi Diluter Jet (Fixed O2 Percentage) 50% Pink	100
221060	Venturi Diluter Jet (Fixed O2 Percentage) 60% Green	100

**VENTURI MASK KITS**

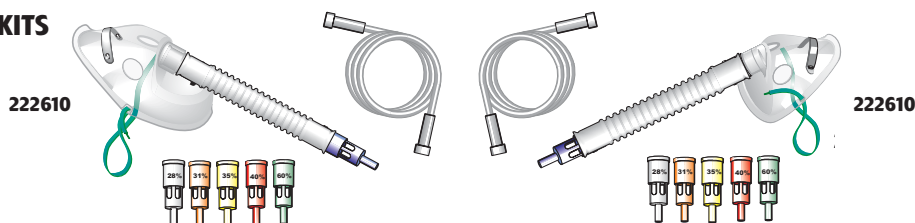

CODE	DESCRIPTION	BOX QTY
222610	Adult Venturi Mask Kit w/ 6 Venturi Diluter Jets	50
222620	Paediatric Venturi Mask Kit w/ 6 Venturi Diluter Jets	50

**VENTURI MASK KITS  
DIRECT JET FITTING**

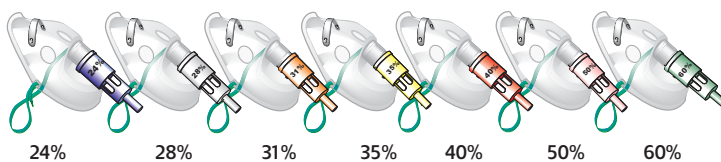

CODE	DESCRIPTION	BOX QTY
22142624	Adult Venturi Mask with Direct Fit Venturi 24% -blue	50
22142628	Adult Venturi Mask with Direct Fit Venturi 28% -white	50
22142631	Adult Venturi Mask with Direct Fit Venturi 31% -orange	50
22142635	Adult Venturi Mask with Direct Fit Venturi 35% -yellow	50
22142640	Adult Venturi Mask with Direct Fit Venturi 40% -red	50
22142650	Adult Venturi Mask with Direct Fit Venturi 50% -pink	50
22142660	Adult Venturi Mask with Direct Fit Venturi 60% -green	50

Tel +44 (0) 1258 471 770  
Fax +44 (0) 1258 471 772

Meditech Systems Limited  
Unit 3 Richmar  
Butt's Pond Ind.Estate  
Sturminster Newton  
Dorset DT10 1AZ

**meditech**  
systems limited

FOR ALL ORDERS CALL DIRECT **0700 - 4 - MEDITECH**

**ALL  
COMPONENTS  
LATEX  
FREE**

**MEDI-MIST NEBULISER**

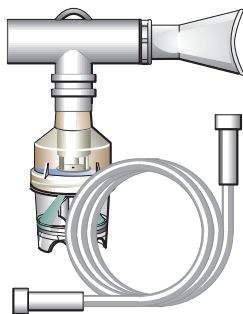

227723

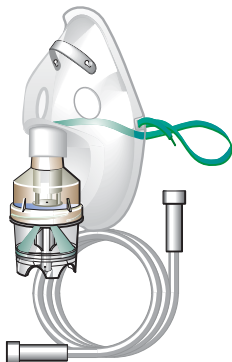

227762

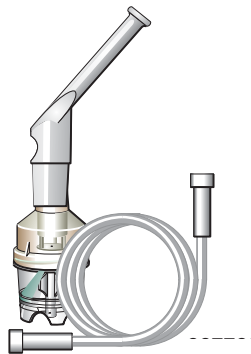

227722

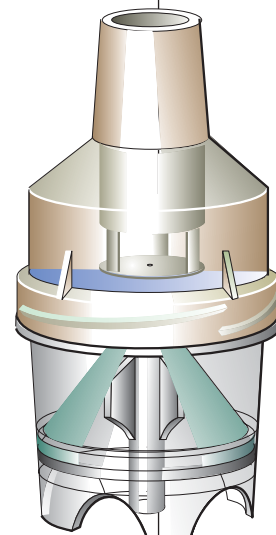

227760

CODE	DESCRIPTION	BOX QTY
227760	Medi-Mist Nebuliser Only	100
227762	Medi-Mist Nebuliser with Adult Mask & Tubing	50
227772	Medi-Mist Nebuliser with Paed Mask & Tubing	50
227722	Medi-Mist Nebuliser with angled Mouthpiece & Tubing	50
227723	Medi-Mist Nebuliser with T piece mouthpiece & Tubing	50
22771575	Medi-Mist Nebuliser with one-way valves system (antibiotic etc)	25
22776622	Medi-Mist Nebuliser In-line system for Adult Circuits	25
22776615	Medi-Mist Nebuliser In-line system for Paediatric Circuits	25
22776610	Medi-Mist Nebuliser In-line system for Neonate Circuits	25
22776605L	Medi-Mist Nebuliser In-line system for Neonate Bagging	10

**HUMIDIFIERS AND NEBULISERS**

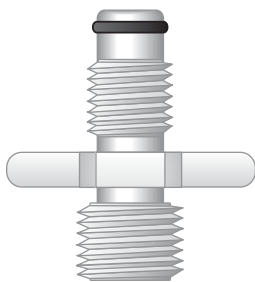

22810158

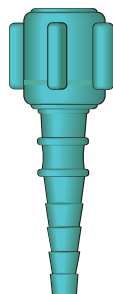

22810159

222302

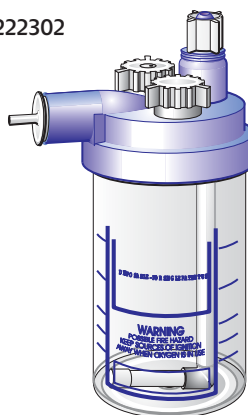

222305

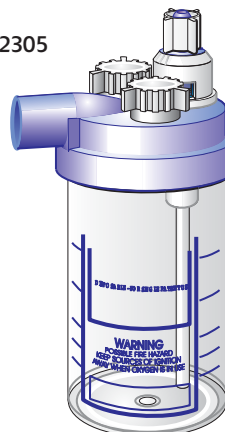

CODE	DESCRIPTION	BOX QTY
222305	Nebuliser Jar Refillable 35% - 100% Oxygen	24
222302	Humidifier Jar Refillable Bubble Through Style	24
22228	Nebuliser Head 28% - 100% Oxygen	50
22810158	BOC adaptor to connect above items to Flowmeter.	100
22810159	BOC adaptor to connect above items to Flowmeter.	100

medi  
tech  
systems limited

Meditech Systems Limited  
Unit 3 Richmond  
Butt's Pond Industrial Estate  
Sturminster Newton  
Dorset DT10 1AZ

Tel +44 (0) 1258 471 770  
Fax +44 (0) 1258 471 772

**ALL  
COMPONENTS  
LATEX  
FREE**

**20 >>**

Accessories & Connectors

### T PIECE CONNECTORS

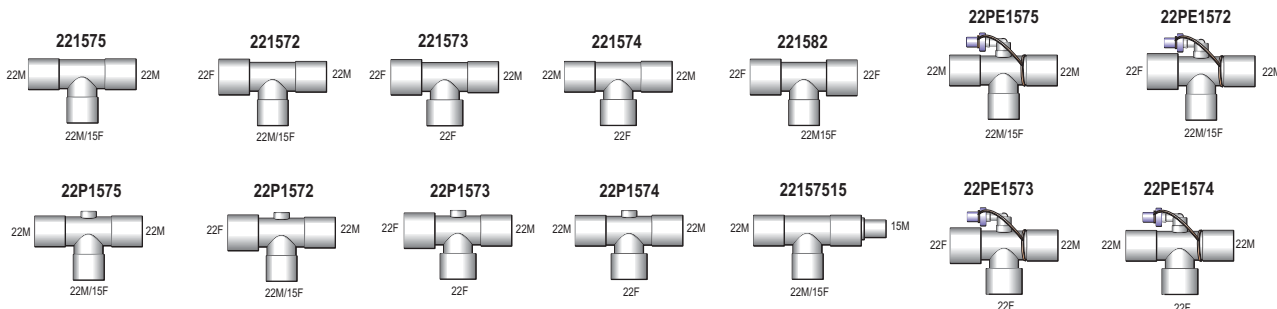

CODE	DESCRIPTION	BOX QTY
221575	T Piece 22M/15F x (22M/15F) x 22M/15F	50
221572	T Piece 22F x (22M/15F) x 22M/15F	50
221573	T Piece 22F x (22F) x 22M/15F	50
221574	T Piece 22M/15F x (22F) x 22M/15F	50
221582	T Piece 22F x (22M/15F) x 22F	50
22P1575	T Piece 22M/15F x (22M/15F) x 22M/15F with 7.6mm Port	50
22P1572	T Piece 22F x (22M/15F) x 22M/15F with 7.6mm Port	50
22P1573	T Piece 22F x (22F) x 22M/15F with 7.6mm Port	50
22P1574	T Piece 22M/15F x (22F) x 22M/15F with 7.6mm Port	50
22157515	T Piece 22M/15F x (22M/15F) x 15M	50
22PE1575	T Piece 22M/15F x (22M/15F) x 22M/15F with Elbow	50
22PE1572	T Piece 22F x (22M/15F) x 22M/15F with Elbow	50
22PE1573	T Piece 22F x (22F) x 22M/15F with Elbow	50
22PE1574	T Piece 22M/15F x (22F) x 22M/15F with Elbow	50

CODE	DESCRIPTION	BOX QTY
228310	Standard Adult Parallel Y Piece (22M x (22M/15F) x 22M)	24
22P8310	Ported Adult Parallel Y Piece (22M x (22M/15F) x 22M)	24
22SW8310	Swivel Adult Parallel Y Piece (22M x (22M/15F) x 22M)	50
225107	Standard Adult Bi-rificated Y Piece (22M x (22M/15F) x 22M)	100
22P5107	Ported Adult Bi-rificated Y Piece (22M x (22M/15F) x 22M)	100
2250175	Paediatric Parallel Y Piece (15M x (22M/15F) x 15M)	100

### Y PIECE CONNECTORS

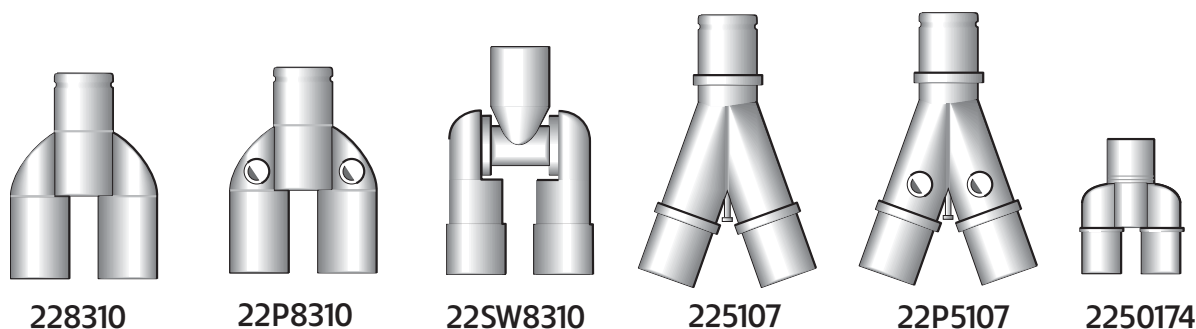

Meditech Systems Limited  
Unit 3 Richmar  
Butt's Pond Ind.Estate  
Sturminster Newton  
Dorset DT10 1AZ

**meditech**  
systems limited

FOR ALL ORDERS CALL DIRECT **0700 - 4 - MEDITECH**

**ALL  
COMPONENTS  
LATEX  
FREE**

**22MM CONNECTORS**

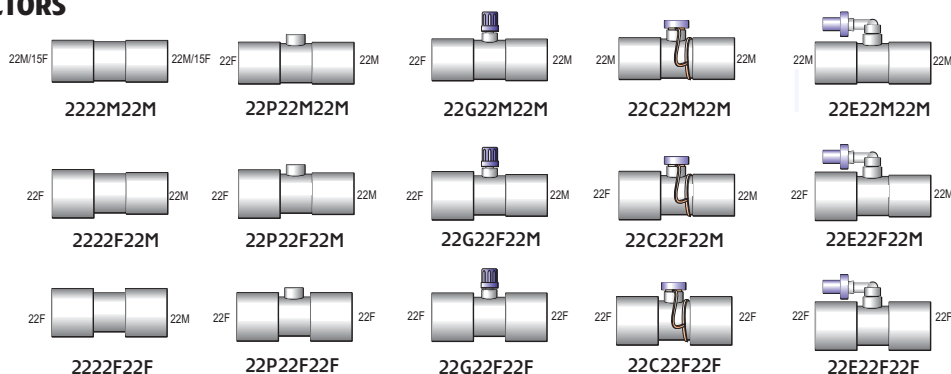

CODE	DESCRIPTION	BOX QTY
2222M22M	Straight Connector 22M x 22M	50
2222F22M	Straight Connector 22F x 22M	50
2222F22F	Straight Connector 22F x 22F	50
22P22M22M	Straight Connector 22M x 22M Ported	50
22P22F22M	Straight Connector 22F x 22M Ported	50
22P22F22F	Straight Connector 22F x 22M Ported	50
22G22M22M	Straight Connector 22F x 22M Gas Sampling Port	50
22G22F22M	Straight Connector 22F x 22M Gas Sampling Port	50
22G22F22F	Straight Connector 22F x 22M Gas Sampling Port	50
22C22M22M	Straight Connector 22F x 22M Ported & Capped	50
22C22F22M	Straight Connector 22F x 22M Ported & Capped	50
22C22F22F	Straight Connector 22F x 22M Ported & Capped	50
22E22M22M	Straight Connector 22F x 22M Elbow	50
22E22F22M	Straight Connector 22F x 22M Elbow	50
22E22F22F	Straight Connector 22F x 22M Elbow	50

**15mm CONNECTORS**

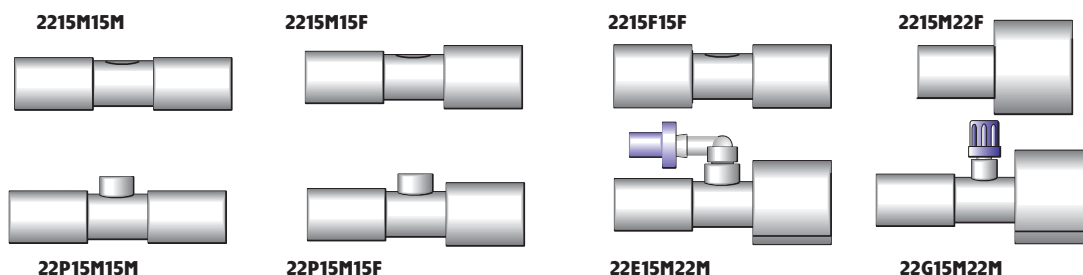

CODE	DESCRIPTION	BOX QTY
2215M15M	Straight Connector 15M x 15M	50
2215M15F	Straight Connector 15M x 15MF	50
2215F15F	Straight Connector 15F x 15F	50
2215M22F	Straight Connector 15M x 22F	50
22P15M15M	Straight Connector 15M x 15M Ported 7.6mm	50
22P15M15F	Straight Connector 15M x 15F Ported 7.6mm	50
22E15M22M	Straight Connector 15M x 22M Elbow	50
22G15M22M	Straight Connector 15M x 22M Gas Sampling Port	50

meditech  
systems limited

Meditech Systems Limited  
Unit 3 Richmond  
Butt's Pond Industrial Estate  
Sturminster Newton  
Dorset DT10 1AZ

Tel +44 (0) 1258 471 770  
Fax +44 (0) 1258 471 772

**ALL  
COMPONENTS  
LATEX  
FREE**

**22 >>**

Resuscitation

**MANUAL RESUSCITATION**

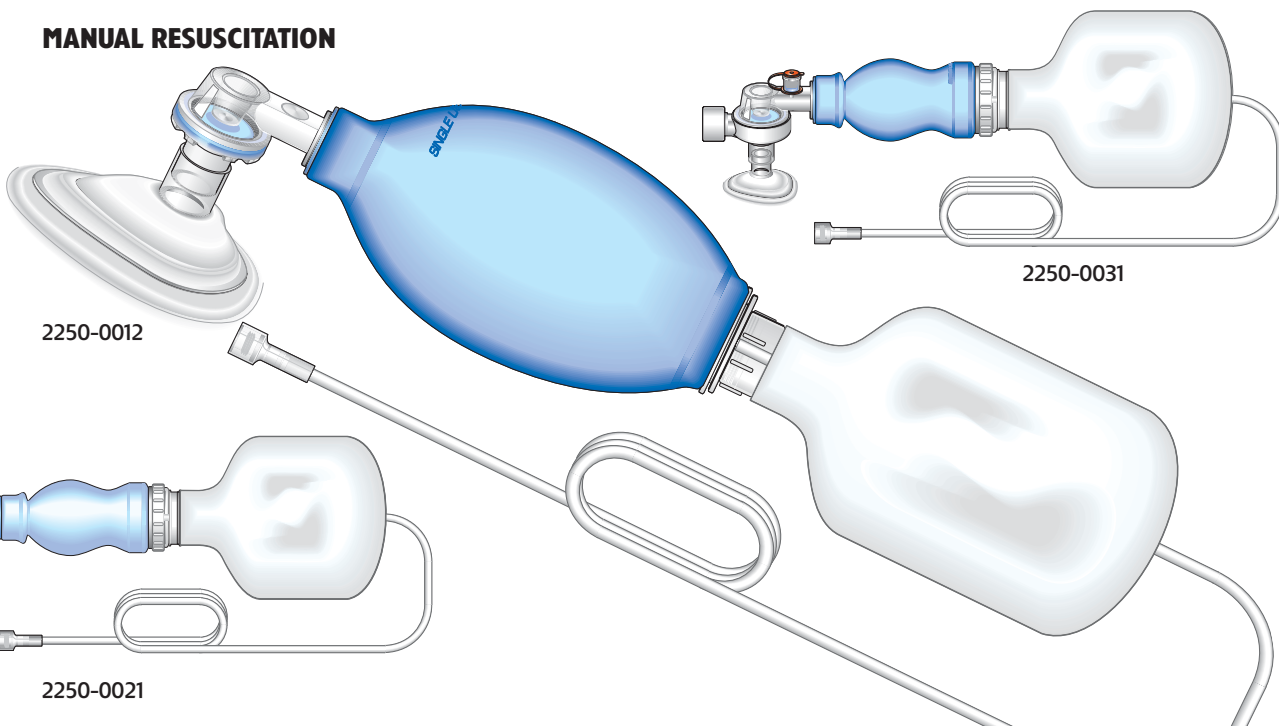

CODE	DESCRIPTION	BOX QTY
2250-0012	Adult Manual Resuscitator Kit, with Mask Reservoir bag and Tubing	6
2250-0021	Child Manual Resuscitator kit with mask Reservoir Bag and Tubing	6
2250-0031	Infant Manual Resuscitator kit with mask Reservoir Bag and Tubing	6

221005

221004

221003

221002

221001

221000

221010

221011

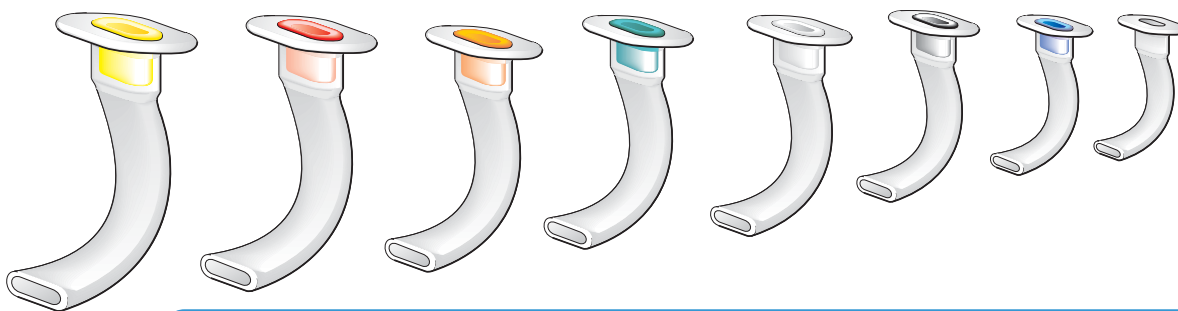

CODE	DESCRIPTION	BOX QTY
221005	Guedel Airway Adult size 5	100
221004	Guedel Airway Adult size 4	100
221003	Guedel Airway Adult size 3	100
221002	Guedel Airway Child size 2	100
221001	Guedel Airway Child size 1	100
221000	Guedel Airway Paediatric size 0	100
221010	Guedel Airway Paediatric size 00	100
221011	Guedel Airway Neonate size 000	100

Tel +44 (0) 1258 471 770  
Fax +44 (0) 1258 471 772

Meditech Systems Limited  
Unit 3 Richmar  
Butt's Pond Ind.Estate  
Sturminster Newton  
Dorset DT10 1AZ

**meditech**  
systems limited

FOR ALL ORDERS CALL DIRECT **0700 - 4 - MEDITECH**

**ALL  
COMPONENTS  
LATEX  
FREE**

23>>

Laryngoscopes

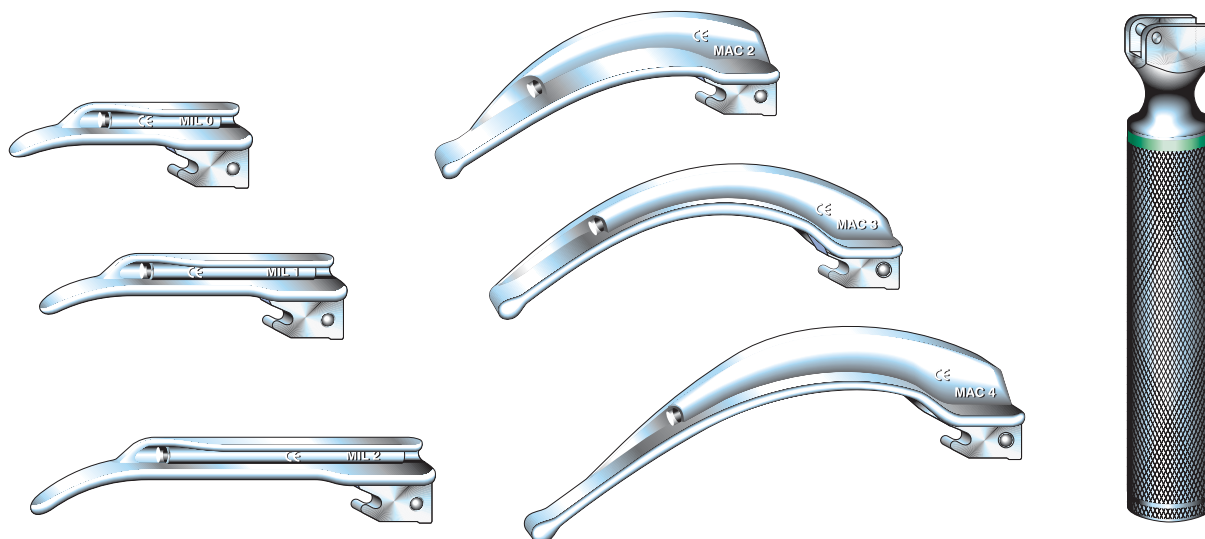

CODE	DESCRIPTION	BOX QTY
227000SS	Disposable Laryngoscope Stainless Steel Miller Blade 0	20
227001SS	Disposable Laryngoscope Stainless Steel Miller Blade 1	20
227002SS	Disposable Laryngoscope Stainless Steel Miller Blade 2	20
226002SS	Disposable Laryngoscope Stainless Steel Macintosh 2	20
226003SS	Disposable Laryngoscope Stainless Steel Macintosh 3	20
226004SS	Disposable Laryngoscope Stainless Steel Macintosh 4.	20
226000SS	Reusable Laryngoscope Handle Stainless Steel	1

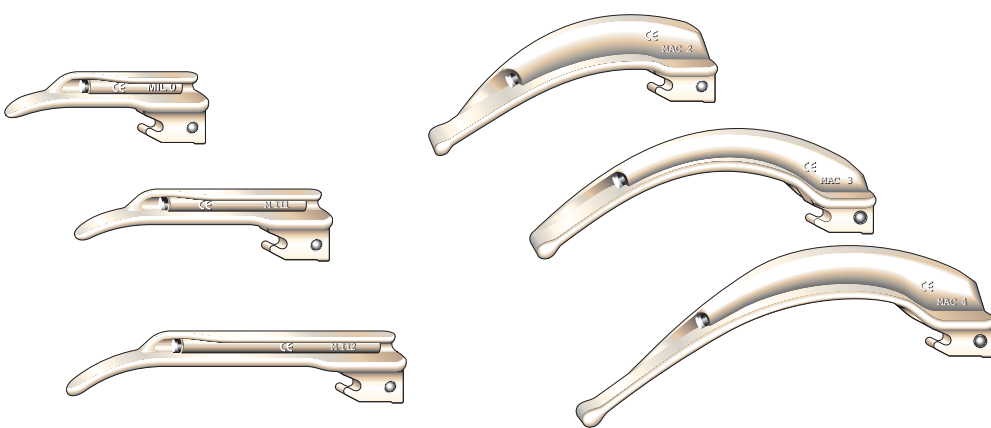

CODE	DESCRIPTION	BOX QTY
227000	Disposable Laryngoscope Plastic Miller Blade 0	20
227001	Disposable Laryngoscope Plastic Miller Blade 1	20
227002	Disposable Laryngoscope Plastic Miller Blade 2	20
226002	Disposable Laryngoscope Plastic Macintosh 2	20
226003	Disposable Laryngoscope Plastic Macintosh 3	20
226004	Disposable Laryngoscope Plastic Macintosh 4	20

meditech  
systems limited

Meditech Systems Limited  
Unit 3 Richmar  
Burt's Pond Ind Estate  
Sturminster Newton  
Dorset DT10 1AZ

Tel +44 (0) 1258 471 770  
Fax +44 (0) 1258 471 772

FOR ALL ORDERS CALL DIRECT **0700 - 4 - MEDITECH**



meditech  
systems limited