

AIRWAY MANAGEMENT PRODUCTS

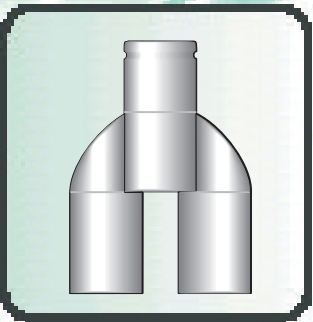
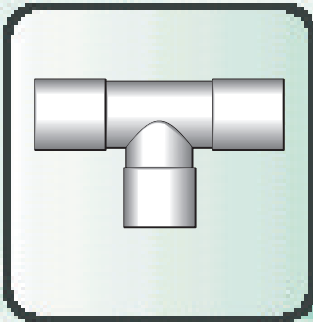

02>>

'T' PIECES

ALL COMPONENTS
LATEX FREE

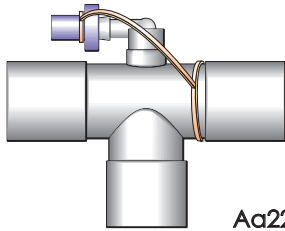

Aa22101

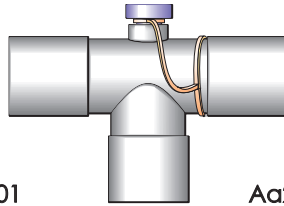

Aa22105

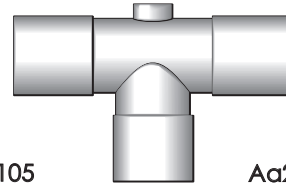

Aa22109

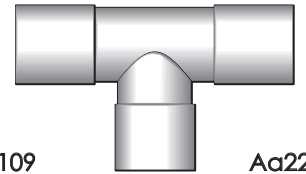

Aa22121

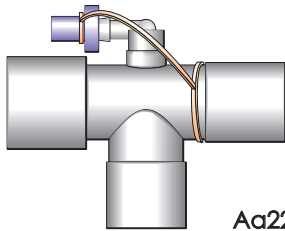

Aa22102

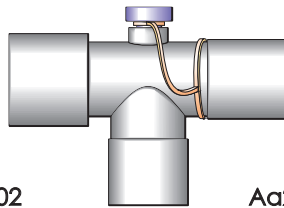

Aa22106

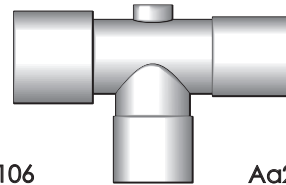

Aa22110

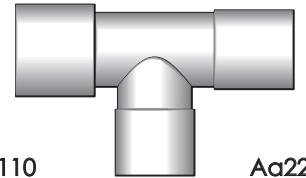

Aa22122

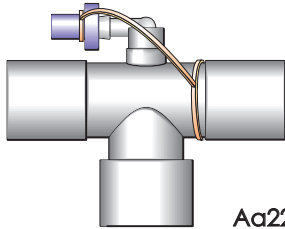

Aa22103

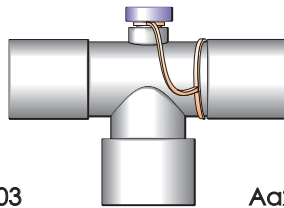

Aa22107

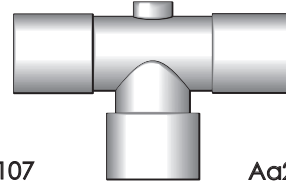

Aa22111

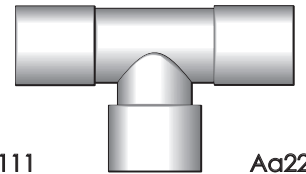

Aa22123

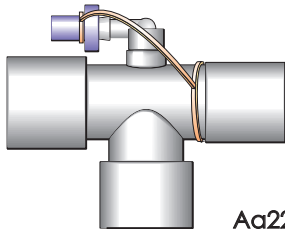

Aa22104

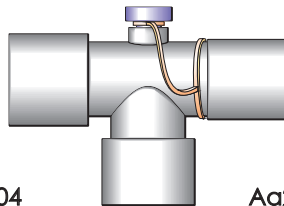

Aa22108

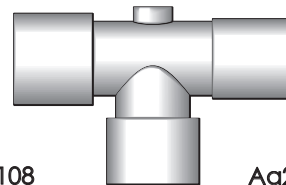

Aa22112

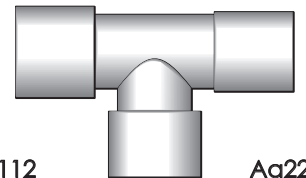

Aa22124

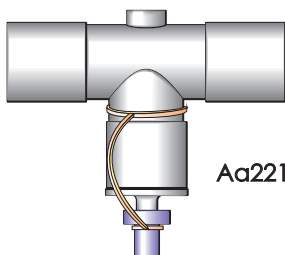

Aa22135

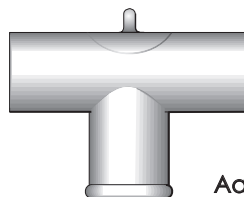

Aa22130

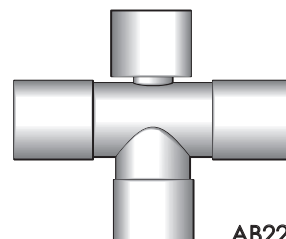

AB22APL1

TEL: +44 (0) 1258 471770
FAX: +44 (0) 1258 471772

Meditech Systems limited
Unit 3 Richmar
Butt's Pond Industrial Estate
Sturminster Newton
Dorset DT10 1AZ

meditech
systems limited

FOR ALL ORDERS CALL DIRECT

0700-4-MEDITECH

Conectors

ALL COMPONENTS
LATEX FREE

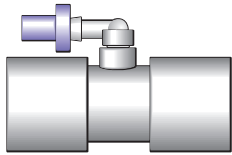

Aa22201

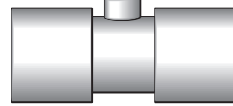

Aa22210

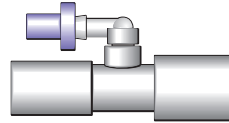

Aa22231

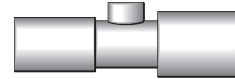

Aa22239

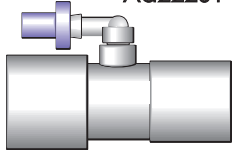

Aa22202

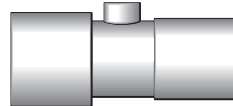

Aa22211

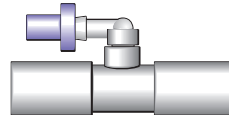

Aa22232

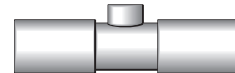

2AA2240

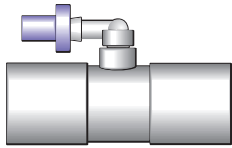

Aa22203

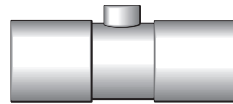

Aa22212

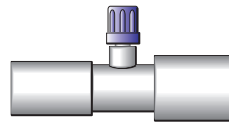

Aa22233

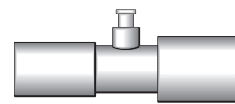

Aa22241

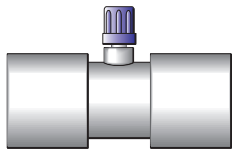

Aa22204

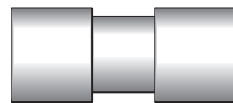

Aa22213

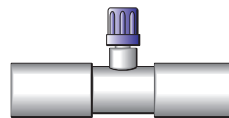

Aa22234

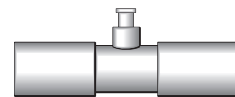

Aa22242

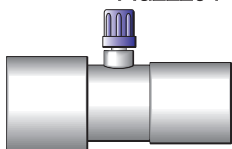

Aa22205

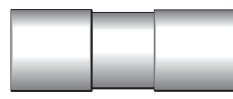

Aa22214

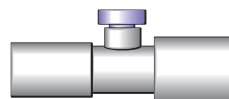

Aa22235

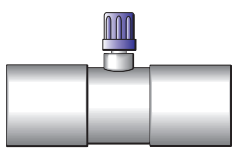

Aa22206

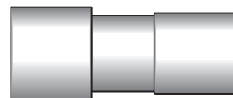

Aa22215

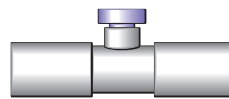

Aa22236

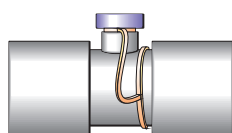

Aa22207

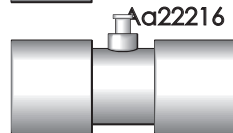

2AA2221

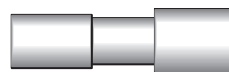

Aa22237

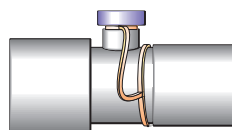

Aa22208

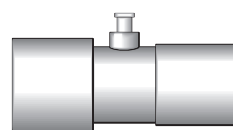

Aa22222



Aa22238

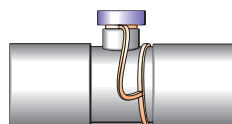

Aa22208

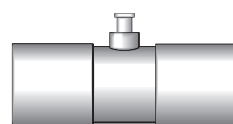

Aa22222

meditech
systems limited

Meditech Systems limited
Unit 3 Richmar
Butt's Pond Industrial Estate
Sturminster Newton
Dorset DT10 1AZ

TEL: +44 (0) 1258 471770
FAX: +44 (0) 1258 471772

**ALL COMPONENTS
LATEX FREE**

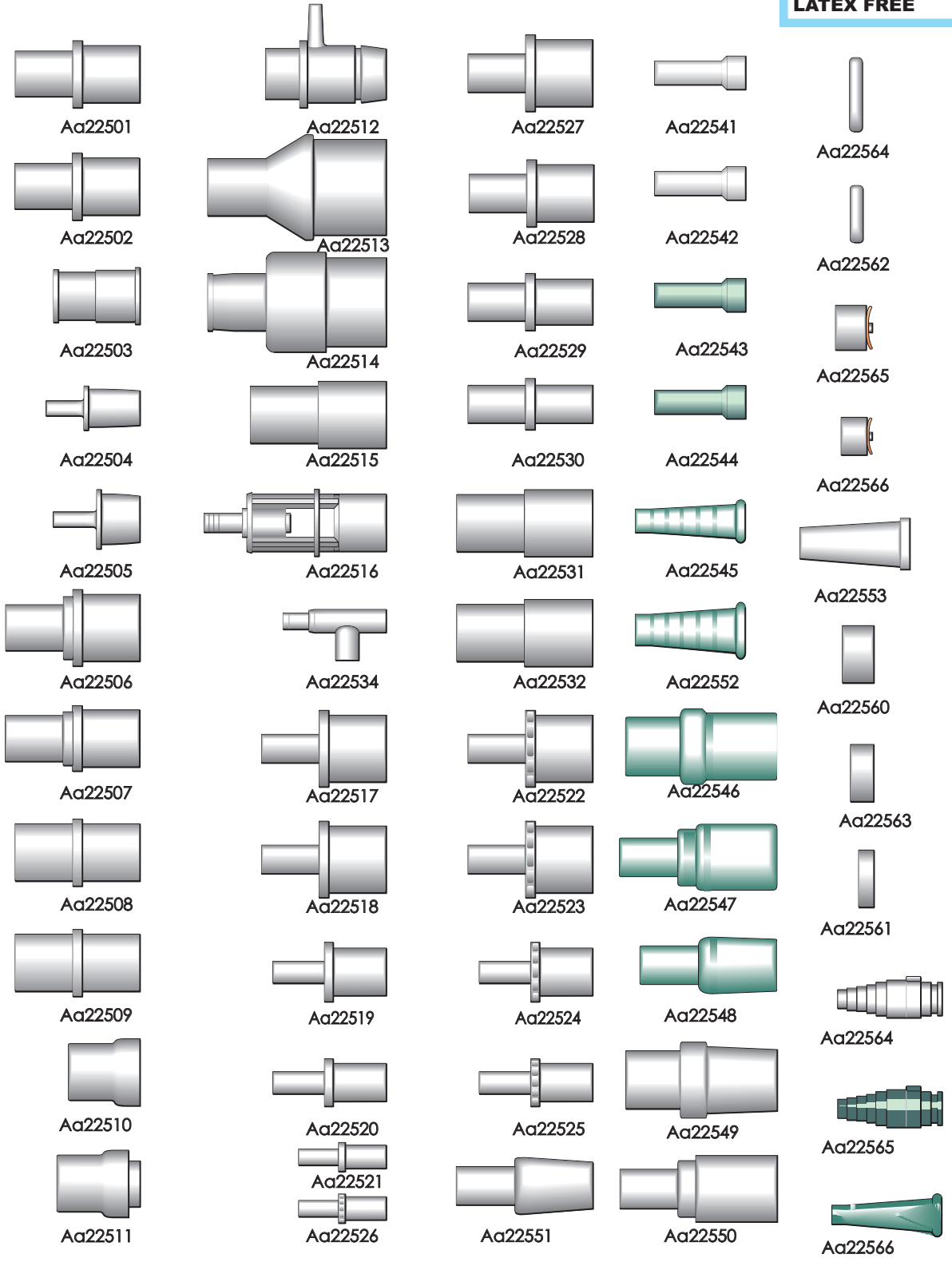

TEL: +44 (0) 1258 471770
 FAX: +44 (0) 1258 471772

Meditech Systems limited
 Unit 3 Richmar
 Butt's Pond Industrial Estate
 Sturminster Newton
 Dorset DT10 1AZ



ALL COMPONENTS
LATEX FREE

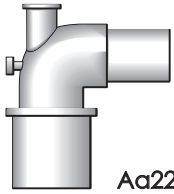

Aa22401



Aa22411

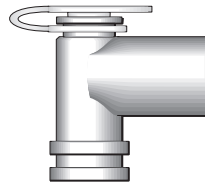

AA221577K
Ported Elbow
(22ODx15ID)
/ 22OD

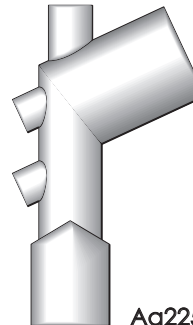

Aa22581

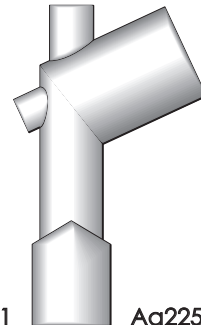

Aa22583

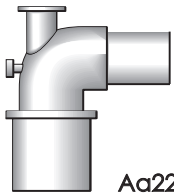

Aa22402



Aa22412

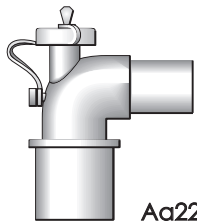

Aa22403



Aa22413

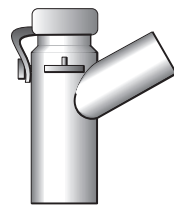

Aa22157708
15ID/15OD
+ METERED
DOSE PORT

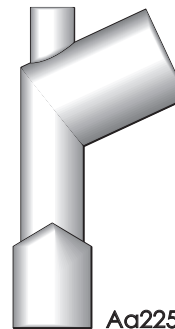

Aa22582

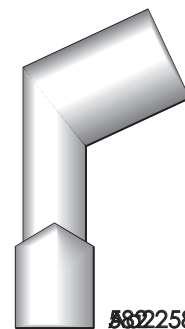

Aa22583

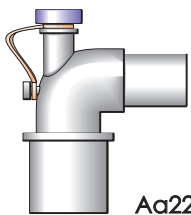

Aa22404

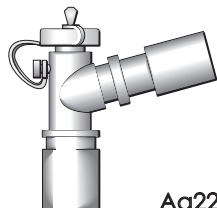

Aa22414

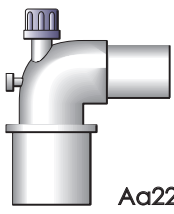

Aa22405

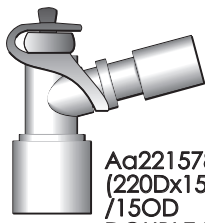

Aa22157802
(22ODx15ID)
/15OD
DOUBLE SWIVEL
+ SUCTION PORT



Aa221691
22OD/22ID

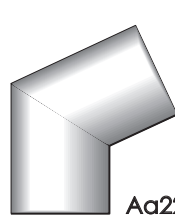

Aa22584

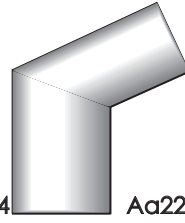

Aa22585

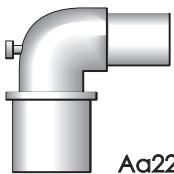

Aa22405



Aa22536



Aa22537

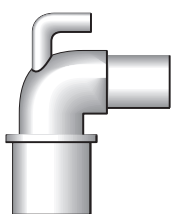

Aa225126
(22ODx15ID)
/15OD +
FRESH GAS ELBOW

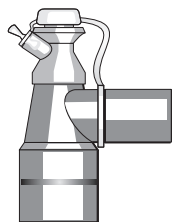

AA22RE157708
(22ODx15ID)
/15OD
SINGLE SWIVEL
for metered dose
administration

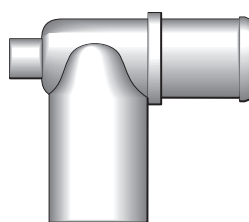

Aa2250668
22OD/22ID
+ 8mm Port
European Bain
Elbow

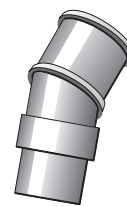

Aa222226
Angled
Aerosol
Connector



Aa22538



Aa22539



Aa22540

meditech
systems limited

Meditech Systems limited
Unit 3 Richmar
Butt's Pond Industrial Estate
Sturminster Newton
Dorset DT10 1AZ

TEL: +44 (0) 1258 471770
FAX: +44 (0) 1258 471772

06>>

'Y' PIECES

ALL COMPONENTS
LATEX FREE

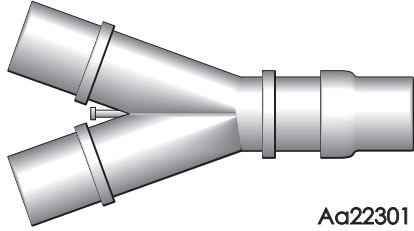

Aa22301

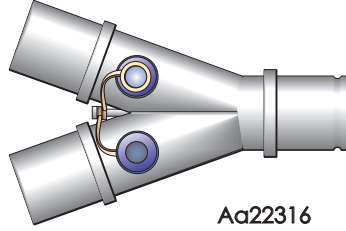

Aa22316

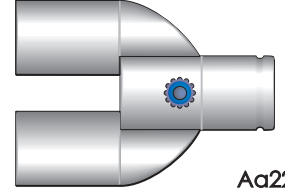

Aa22324

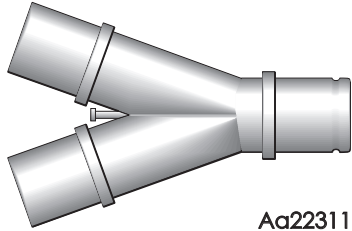

Aa22311

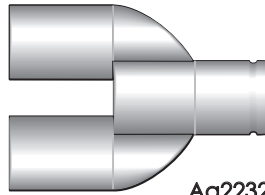

Aa22321

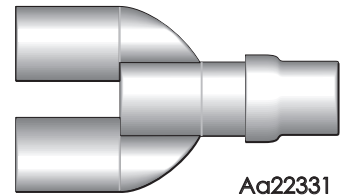

Aa22331

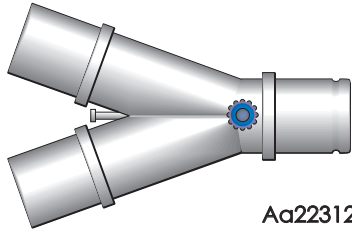

Aa22312

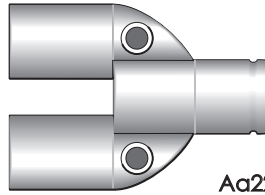

Aa22322

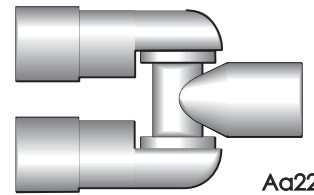

Aa22332

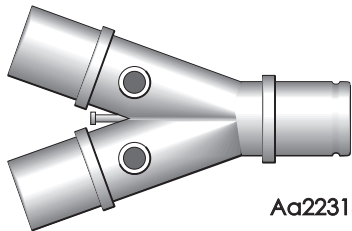

Aa22313

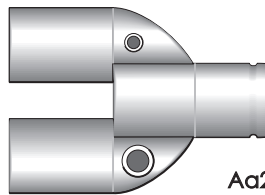

Aa22323

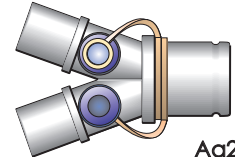

Aa22341

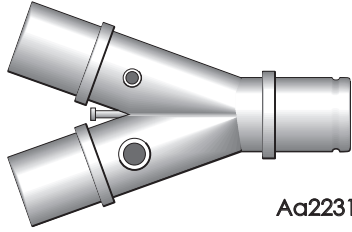

Aa22314

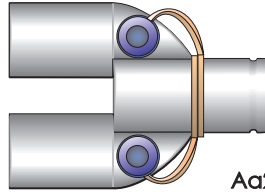

Aa22325

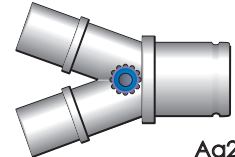

Aa22342

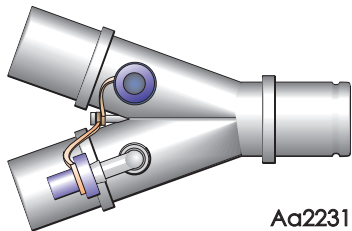

Aa22315

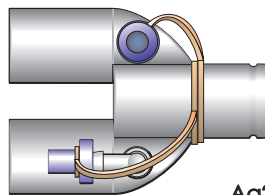

Aa22326

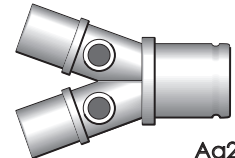

Aa22343

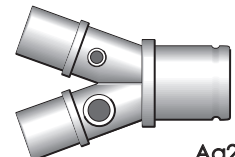

Aa22344

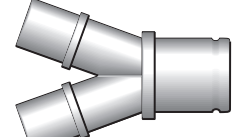
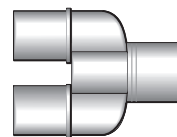
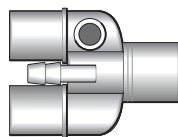
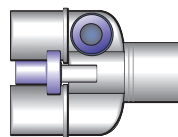
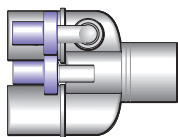

TEL: +44 (0) 1258 471770
FAX: +44 (0) 1258 471772

Meditech Systems limited
Unit 3 Richmar
Butt's Pond Industrial Estate
Sturminster Newton
Dorset DT10 1AZ

meditech
systems limited

FOR ALL ORDERS CALL DIRECT

0700-4-MEDITECH

ALL COMPONENTS
LATEX FREE

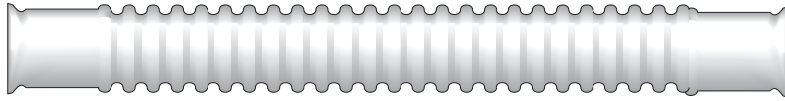

22mm Corrugated Tubing available in various lengths & Cuff Intervals

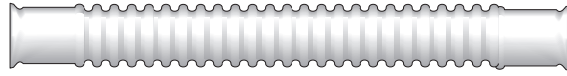

15mm Corrugated Tubing in various lengths & cuff intervals



22mm Smoothbore Tubing in various lengths
choice of end connectors



15mm Smoothbore Tubing in various lengths

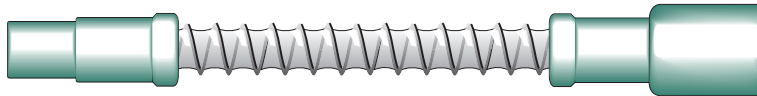

10mm Smoothbore Tubing in various lengths
choice of end Connectors

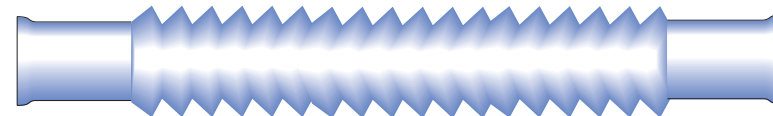
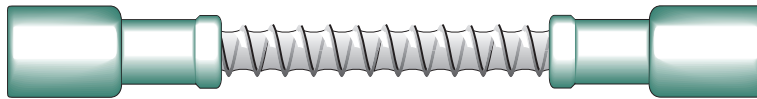

22mm Extendable Tubing
Available in Various lengths
(Also in collapsed form)

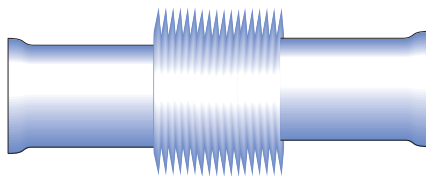

15mm Extendable Tubing
Available in various lengths
(Also in collapsed form)

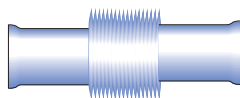

meditech
systems limited

Meditech Systems limited
Unit 3 Richmar
Butt's Pond Industrial Estate
Sturminster Newton
Dorset DT10 1AZ

TEL: +44 (0) 1258 471770
FAX: +44 (0) 1258 471772

08>>

Small Bore Tubing PVC

ALL COMPONENTS
LATEX FREE



Aa221103
1.8M High Pressure
Oxygen Tubing

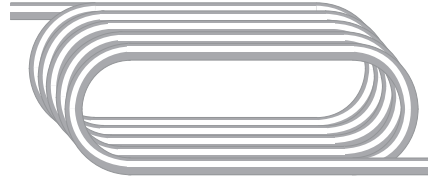

AA221725-05
2.5M High Pressure
Oxygen Tubing

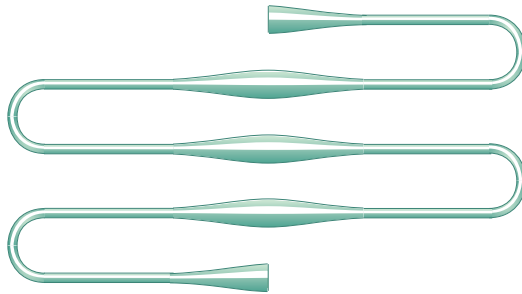

221130 30M Roll Oxygen Bubble Tubing

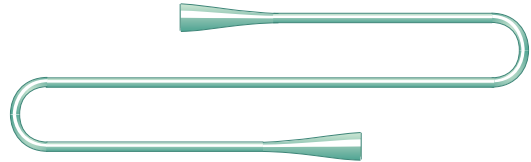

221132 2M Length Oxygen Bubble Tubing

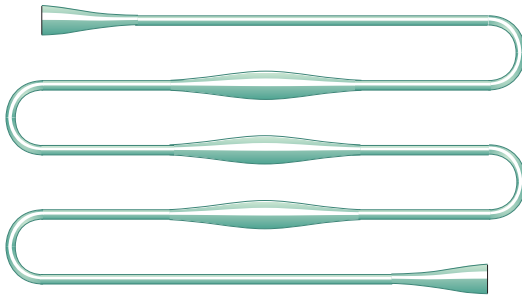

221170 30M Roll Suction Bubble Tubing (Conductive)

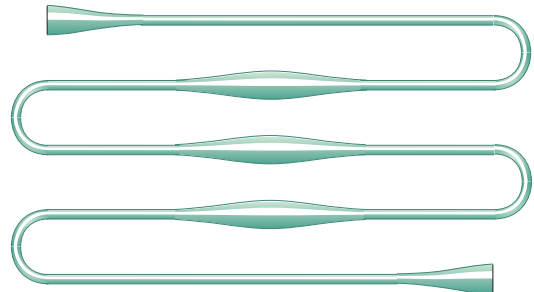

22NC1170 30M Roll Suction Bubble Tubing (Non-Conductive)

TEL: +44 (0) 1258 471770
FAX: +44 (0) 1258 471772

Meditech Systems limited
Unit 3 Richmar
Butt's Pond Industrial Estate
Sturminster Newton
Dorset DT10 1AZ



FOR ALL ORDERS CALL DIRECT

0700-4-MEDITECH

**ALL COMPONENTS
LATEX FREE**

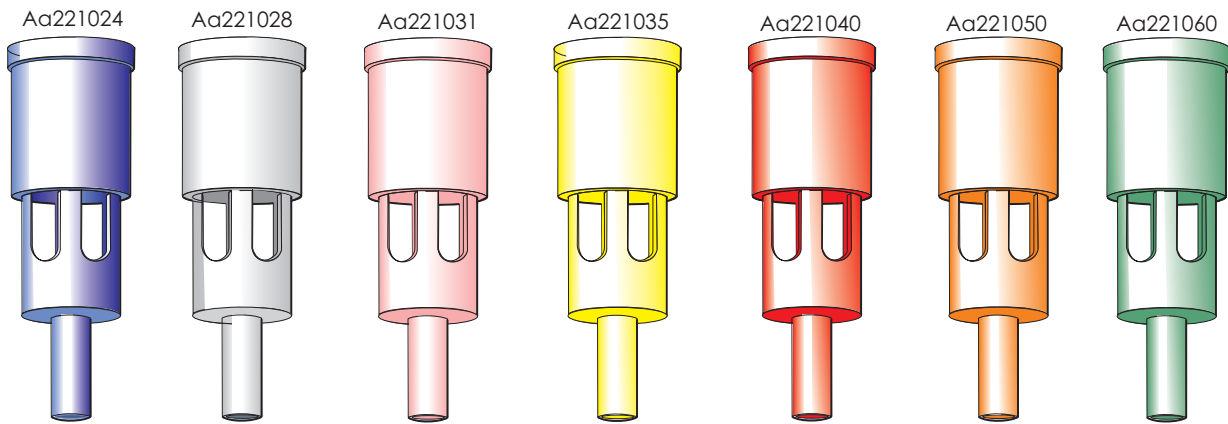
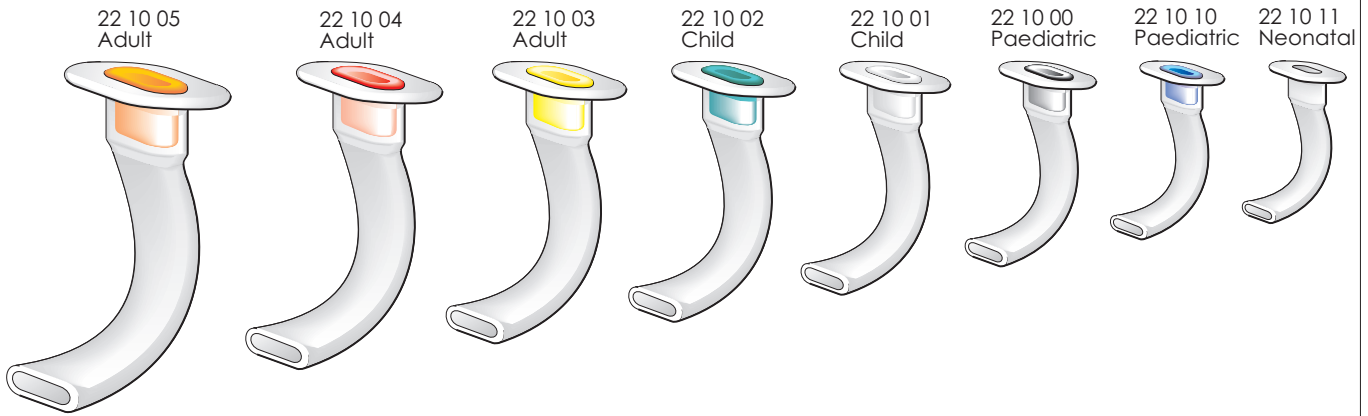

Venturi Jets used in various options as shown

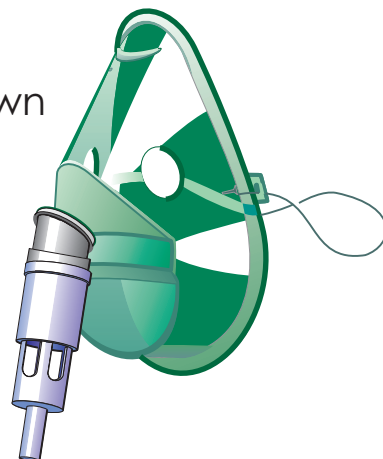
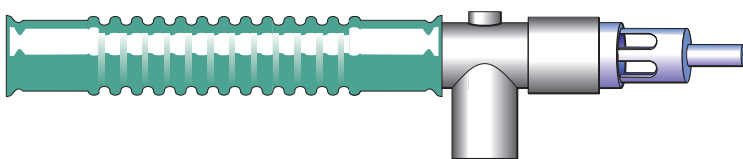

meditech
systems limited

Meditech Systems limited
Unit 3 Richmond
Butt's Pond Industrial Estate
Sturminster Newton
Dorset DT10 1AZ

TEL: +44 (0) 1258 471770
FAX: +44 (0) 1258 471772

02>>

Mouthpieces etc

ALL COMPONENTS
LATEX FREE



554

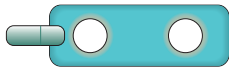

AA1589-2
Nasal Collar

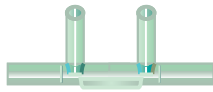

555

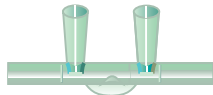

556

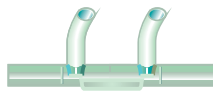

557



558

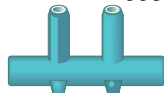

1589
Economy



1583
Soffflex

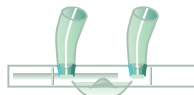

Curved Flared Tip



559

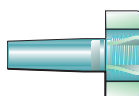

603



604



605



606



607



608



609



612

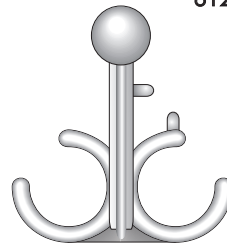

622



623



624

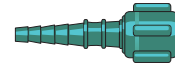

AA810159
Flowmeter
Tubing Adaptor

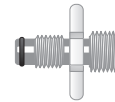

641



650

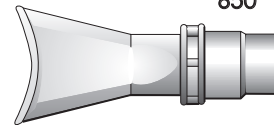

1200 Mouthpiece

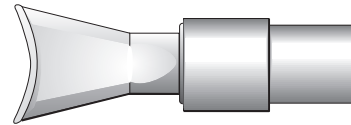

1300 Mouthpiece

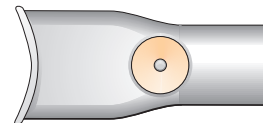

AC261



4460 Mouthpiece

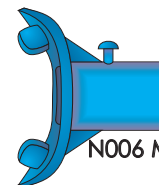

N006 Mouthpiece

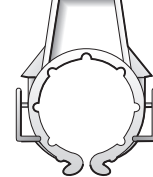

5121
Hanger

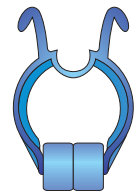

AC28

TEL: +44 (0) 1258 471770
FAX: +44 (0) 1258 471772

Meditech Systems limited
Unit 3 Richmar
Butt's Pond Industrial Estate
Sturminster Newton
Dorset DT10 1AZ

meditech
systems limited

FOR ALL ORDERS CALL DIRECT

0700-4-MEDITECH

ALL COMPONENTS
LATEX FREE

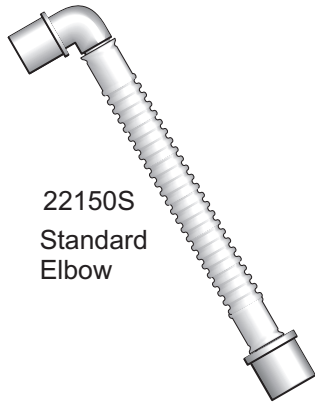

22150S
Standard
Elbow



22150GS
Gas Sampling
Elbow

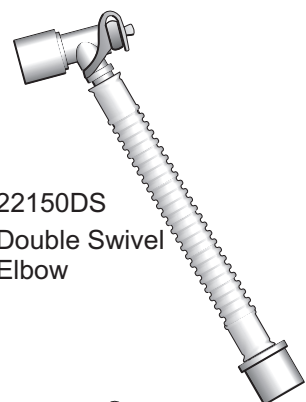

22150DS
Double Swivel
Elbow

**Corrugated
Tubing**

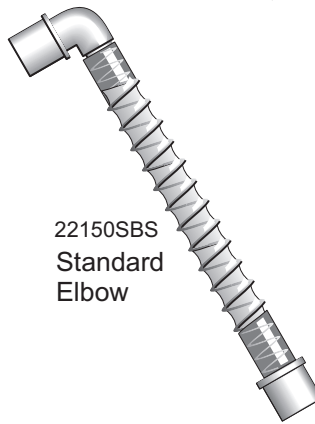

22150SBS
Standard
Elbow



22150SBGS
Gas Sampling
Elbow

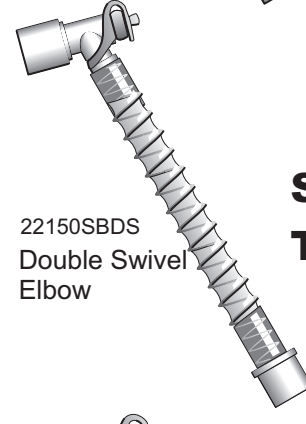

22150SBDS
Double Swivel
Elbow

**Smoothbore
Tubing**

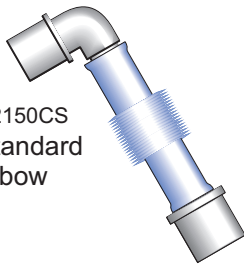

22150CS
Standard
Elbow



22150CGS
Gas Sampling
Elbow

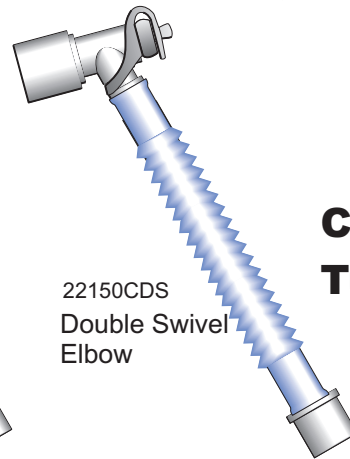

22150CDS
Double Swivel
Elbow

**Collapsible
Tubing**



22150CC
15mm I.D x 22mm I.D.
Collapsible

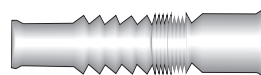

22150CC
15mm I.D x 22mm I.D.
Collapsible



Mediatech Systems limited
Unit 3 Richmar
Butt's Pond Industrial Estate
Sturminster Newton
Dorset DT10 1AZ

TEL +44 (0) 1258 471770
FAX +44 (0) 1258 471772