

ELECTROSURGERY ACCESSORIES

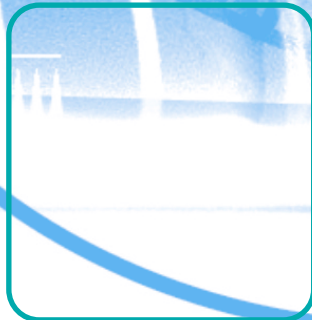
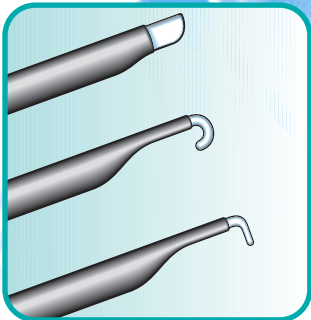
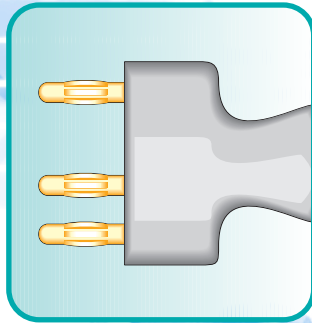

WELCOME TO THE NEW & BIGGER MEDITECH CATALOGUE

EVERY PRODUCT IS A NEW INNOVATION

MEDITECH SYSTEMS
 QUALITY ACCESSORIES
 FOR ELECTROSURGERY

MEDITECH is a well established British based manufacturer which has now emerged as the alternative in electrosurgery accessories.

Our commitment to product innovation borne out of our close customer contact, has proven to be the catalyst for our growth.

Our comprehensive range covers all major makes of electrosurgery generators world-wide & is designed to meet the high quality & safety standards of each market.

Our ability to provide the right product by design for specific clinical needs is nurtured by close liaison with our clinical partners. This approach provides benefits to both patient & clinician.

Our aim at Meditech is to grow through partnership with our customers providing the quality & service required in today's healthcare industry.

Our commitment is backed by increased capacity in our new facility offering the following:-see below

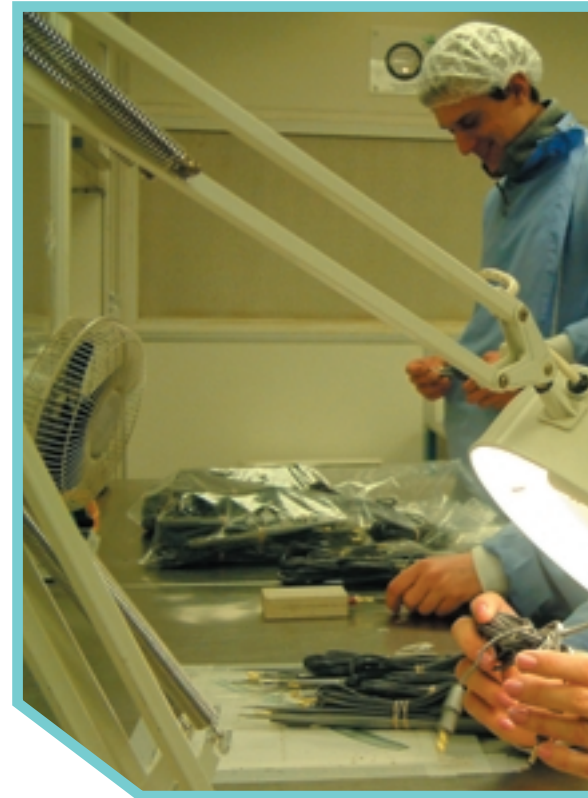

CLEANROOM FACILITIES FOR PROCESSING

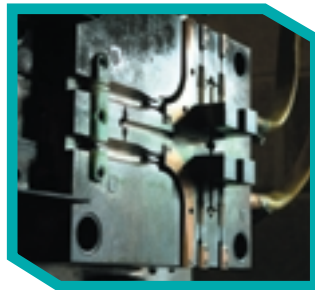

IN-HOUSE TOOLING DESIGN



IN-HOUSE MOULDING

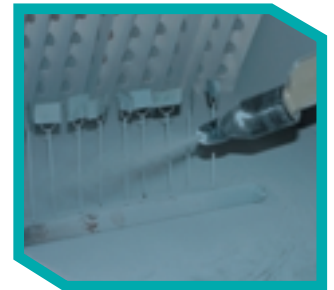

NYLON COATING PLANT



ALL MEDITECH PRODUCTS CARRY THE CE MARK OF QUALITY ASSURANCE.



PHOTOGRAPHY : REBEKAH GODDARD ILLUSTRATION : SIMON VENN

FOR ALL ORDERS CALL DIRECT **0700 - 4 - MEDITECH**

+44 (0) 1258 471 770
 +44 (0) 1258 471 772

Meditech Systems Limited
 Unit 3 Richmar
 Butt's Pond Ind.Estate
 Sturminster Newton
 Dorset DT10 1AZ

contents... contents... contents... contents... contents... contents... contents... contents... contents...



PENCILS

Hand control pencils

04

Foot control pencils

05

ELECTRODES

Pencil Electrodes

06 - 07

Monel handles & electrodes

08

Patient plates & cables

09

CABLES

Monopolar cables

10 - 11

Bipolar cables

12 - 13

FORCEPS & SCISSORS

Bipolar forceps

14 - 15

Disposable forceps

16 - 17

Monopolar forceps

18

Monopolar forceps & scissors

19

COLPOSCOPY/LLETZ

Loop & ball electrodes

20 - 21

GYNAECOLOGY

Gynaecology instruments

22

Biopsy instruments

23

ENT

ENT instruments

24 - 27

PROCTOLOGY

Proctology & general/cardiac

28 - 29

FIBRE OPTICS

Light cables

30

Light carriers & accessories

31

LAPAROSCOPIC

Electrodes & scissors

32

REPAIR SERVICES

Repair services

33

AIRWAY MANAGEMENT

Anaesthesia accessories

34

Respiratory accessories

35

INTERACTIVE CD

■ "EASY ICAN" ORDERING SYSTEM.

On-screen product specification

■ ON-SCREEN CUSTOM DESIGN

Add your input to product design.

■ WEB LINK

for Updates & Ordering

Send via e-mail your drawing/order

■ WITH ICAN YOU CAN

create your custom product

contact us for your **FREE** demo



**AVAILABLE
ON REQUEST
OnCD**



single use option
please use prefix SU

wherever you see this logo
please note that you have
the option of single -use on
the products shown

meditech
systems limited

Meditech Systems Limited
Unit 3 Richmond
Butt's Pond Ind Estate
Sturminster Newton
Dorset DT10 1AZ

Tel: +44 (0) 1258 471 770
Fax: +44 (0) 1258 471 772

04 >>

Hand control pencils

"DURA - SWITCH" REUSABLE

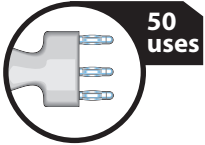

50 uses

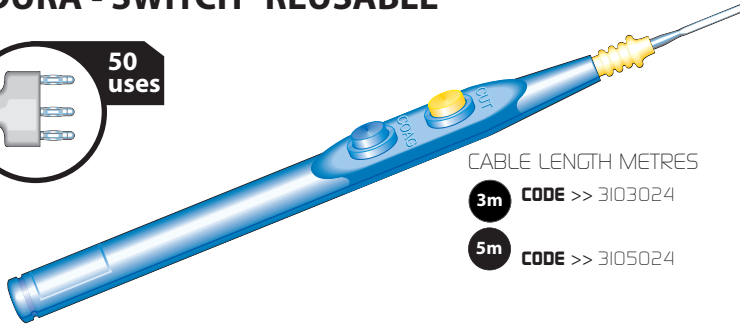

CABLE LENGTH METRES

3m CODE >> 3103024

5m CODE >> 3105024

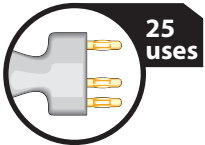

25 uses

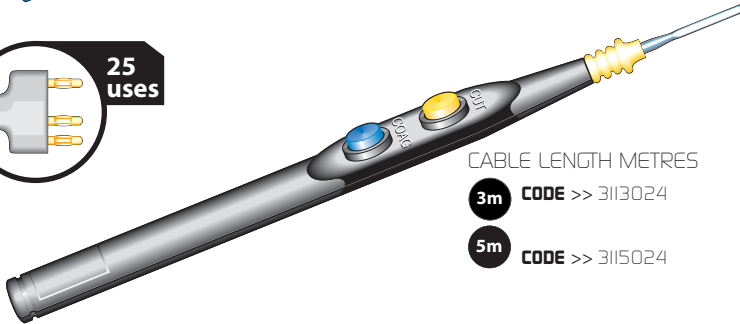

CABLE LENGTH METRES

3m CODE >> 3113024

5m CODE >> 3115024

SINGLE USE

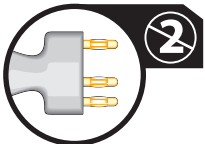

2

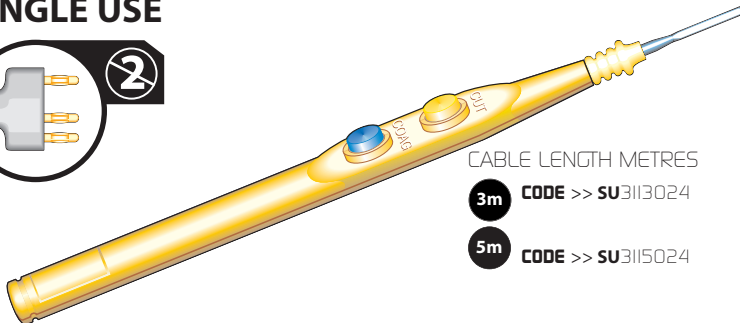

CABLE LENGTH METRES

3m CODE >> SU3113024

5m CODE >> SU3115024

FEATURES



- 1** RELIABLE SPRUNG CAGE PIN DESIGN
- 2** SEALED DOUBLE INSULATED & WATERPROOF SWITCHES
- 3** "HI-FLEX" SILICONE CABLE



- 1** STANDARD 4MM PIN
- 2** SEALED DOUBLE INSULATED & WATERPROOF SWITCHES
- 3** "HI-FLEX" SILICONE CABLE



- 1** STANDARD 4MM PIN
- 2** LOW PROFILE BUTTONS
- 3** "HI-FLEX" PVC CABLE

SCRATCH PAD
FOR CLEANING
ELECTRODES
CODE >> 317520

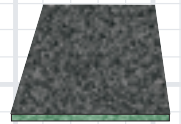

ADAPTORS

ALLOWING CONNECTION OF HAND CONTROL PENCILS (3 PIN PLUG) TO LISTED GENERATORS



EXTENSION CABLE
CODE >> 31030400

ADAPTORS

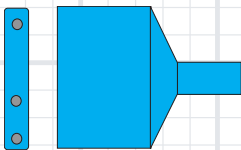

ESHMANN ADAPTOR
CODE >> 3144440

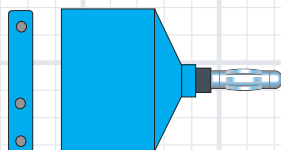

ERBE ADAPTOR
CODE >> 3144450

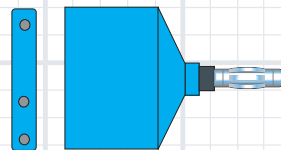

NEOMED ADAPTOR
CODE >> 3144441

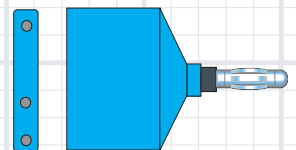

MARTIN ADAPTOR
CODE >> 3144442

+44 (0) 1258 471 770
+44 (0) 1258 471 772



Meditech Systems Limited
Unit 3 Richmar
Butt's Pond Ind.Estate
Sturminster Newton
Dorset DT10 1AZ



FOR ALL ORDERS CALL DIRECT **0700 - 4 - MEDITECH**

SLIM-LINE PENCILS

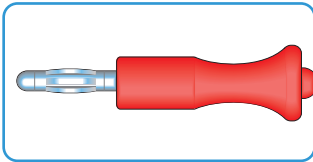

CABLE LENGTH METRES

3m CODE >> 31403024

5m CODE >> 31405024

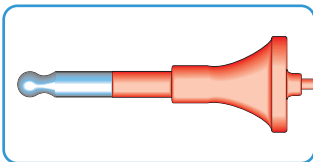

CABLE LENGTH METRES

3m CODE >> 31803024

5m CODE >> 31805024

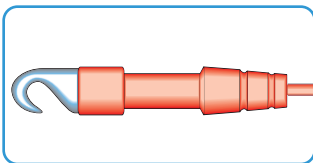

CABLE LENGTH METRES

3m CODE >> 31303024

5m CODE >> 31305024

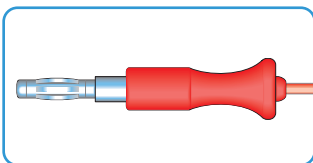

CABLE LENGTH METRES

3m CODE >> 31503024

5m CODE >> 31505024

FEATURES

NEW SLIM-LINE DESIGN:

- lightweight
- push fit electrode connection
- range of electrodes available
- "hi-flex" silicone cables

CODE >> 314824

4.8mm

CODE >> 314024

4.0mm

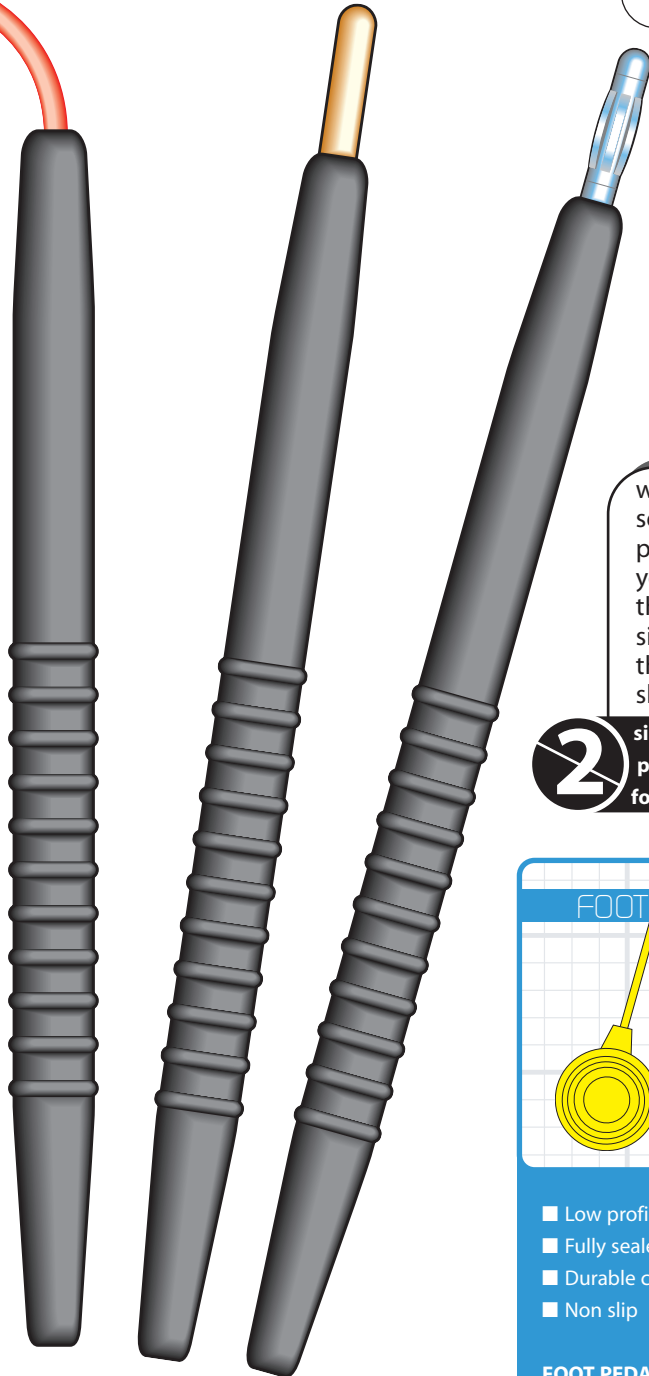

wherever you see this logo please note that you have the option of single-use on the products shown

2 single use option please use prefix SU for single use

FOOT PEDALS

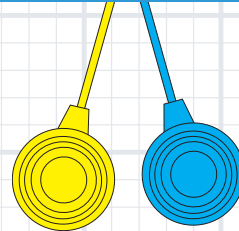

- Low profile
- Fully sealed
- Durable cable
- Non slip

FOOT PEDALS AVAILABLE FOR ALL GENERATORS ON REQUEST

meditech
systems limited

Meditech Systems Limited
Unit 3 Richmond
Butt's Pond Industrial Estate
Sturminster Newton
Dorset DT10 1AZ

Tel +44 (0) 1258 471 770
Fax +44 (0) 1258 471 772

06 >>

Pencil electrodes

BLADE & SPATULA ELECTRODES

NEEDLE & BLADE ELECTRODES

needle options
STAINLESS
STEEL &
TUNGSTEN

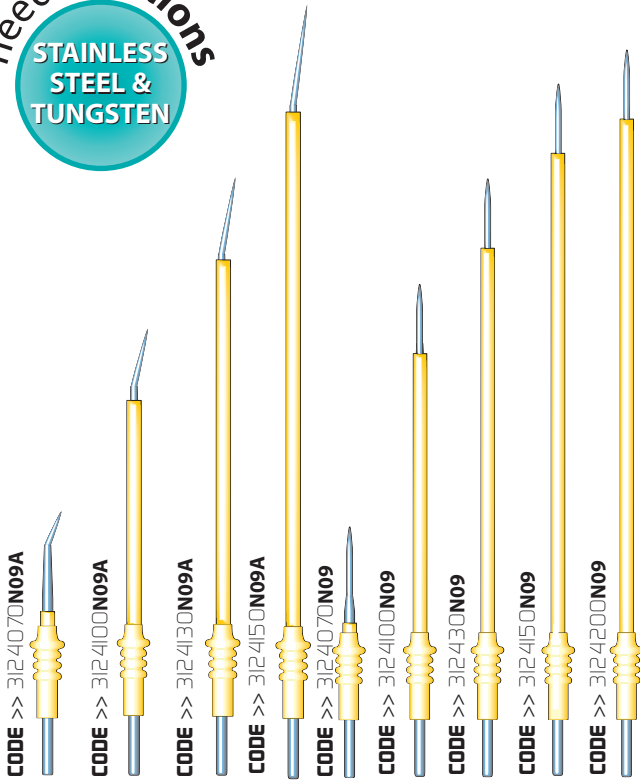

CODE >> 3124070N09A

CODE >> 3124100N09A

CODE >> 3124130N09A

CODE >> 3124150N09A

CODE >> 3124070N09

CODE >> 3124100N09

CODE >> 3124130N09

CODE >> 3124150N09

CODE >> 3124200N09

CODE >> 3124070SA

CODE >> 3124100SA

CODE >> 3124130SA

CODE >> 3124150SA

CODE >> 3124200SA

CODING FORMAT EXAMPLE

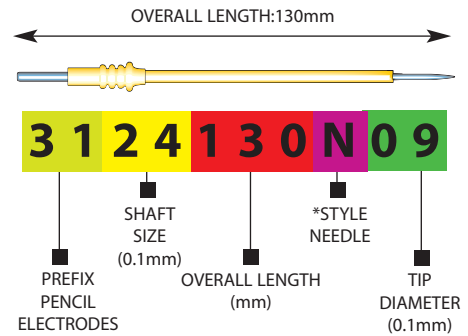

*S = spatula N = needle B = ball
H=hook HD = hook dagger

EXTRA FEATURES

OPTIONS AVAILABLE ON ALL ELECTRODES:

- "FLEXI"-SHAFT
- "NON-STICK" COATING
- NYLON INSULATED TIPS
- CUSTOM LENGTHS AVAILABLE ON REQUEST

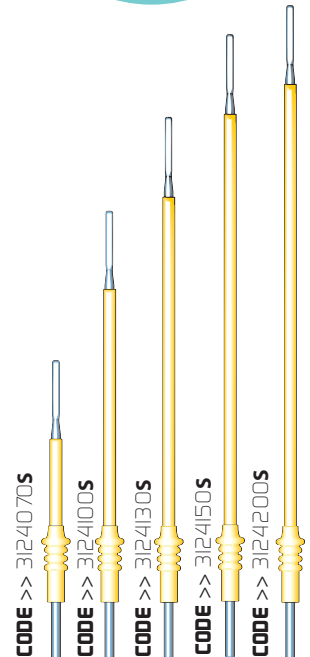
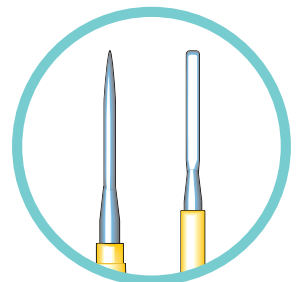

CODE >> 3124070S

CODE >> 3124100S

CODE >> 3124130S

CODE >> 3124150S

CODE >> 3124200S

2 single use option
please use prefix SU

wherever you see this logo please note that you have the option of single -use on the products shown

FOR ALL ORDERS CALL DIRECT 0700 - 4 - MEDITECH

+44 (0) 1258 471 770
+44 (0) 1258 471 772

TEL 010
FAX 010

Meditech Systems Limited
Unit 3 Richmar
Butt's Pond Ind.Estate
Sturminster Newton
Dorset DT10 1AZ

meditech
systems limited

ARTHROSCOPIC & BALL ELECTRODES

BALL ELECTRODES

NON-STICK COATING

CODE >> 3324200B5NS
 prefix code with 33 for all "flexi-shaft" products

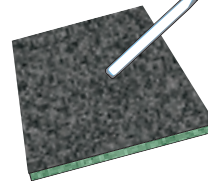
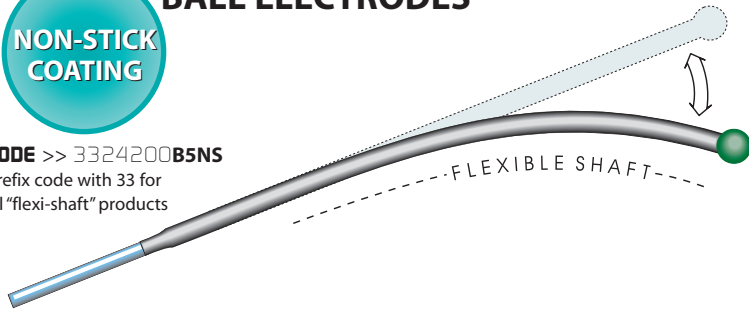

CLEANING SCRATCH PAD
CODE >> 317520

CODE >> 3124150B5A

CODE >> 3124130B5A

CODE >> 3124100B5A

CODE >> 3124070B5A

ARTHROSCOPIC ELECTRODES HOOK & DAGGER STYLE

CODE >> 3124180HD

CODE >> 3124140HD

CODE >> 3124120HD

CODE >> 3124180H

CODE >> 3124140H

CODE >> 3124120H

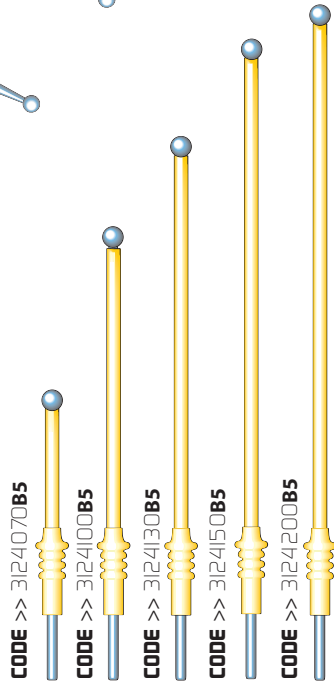

EXTRA FEATURES

OPTIONS AVAILABLE ON ALL ELECTRODES:

- "FLEXI - SHAFT"
- "NON-STICK" COATING
- NYLON INSULATED TIPS



Mediatech Systems Limited
 Unit 3 Richmond
 Butts Pond Ind Estate
 Sturminster Newton
 Dorset DT10 1AZ

Tel +44 (0) 1258 471 770
 Fax +44 (0) 1258 471 772

08 >>

Monel handles
& electrodes

MONEL HANDLES 9BA



BRISTOL HANDLE CODE >> 31481209



CODE >> 31482009



CODE >> 31481509

9BA THREAD ELECTRODES



CODE >> 3195506



CODE >> 3195008

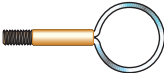

CODE >> 3195510

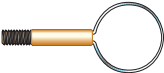

CODE >> 3195012

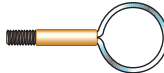

CODE >> 3195514

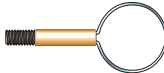

CODE >> 3195016

- 1 >> **CODE 3195007**
- 2 >> **CODE 3193207**
- 3 >> **CODE 3195007A**
- 4 >> **CODE 3195010**
- 5 >> **CODE 3193210**
- 6 >> **CODE 3195010A**
- 7 >> **CODE 3195005**
- 8 >> **CODE 3193205**
- 9 >> **CODE 3195005A**

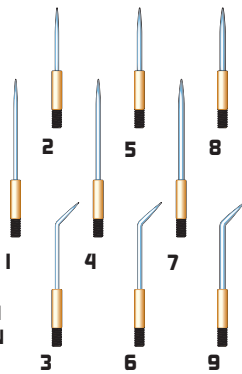

- 1 >> **CODE 319070S**
- 2 >> **CODE 319070N 10IN**
- 3 >> **CODE 319050N 10IN**



BRISTOL NEEDLES



- 4 >> **CODE 319100N 10IN**
- 5 >> **CODE 319100N07IN**
- 6 >> **CODE 319100N05IN**

5BA THREAD ELECTRODES

TRADITIONAL SCREW FIT HANDLES



CODE >> 31481505

- 1 >> **CODE 31570SIN**
- 2 >> **CODE 31570S**
- 3 >> **CODE 315100**
- 4 >> **CODE 315100C**

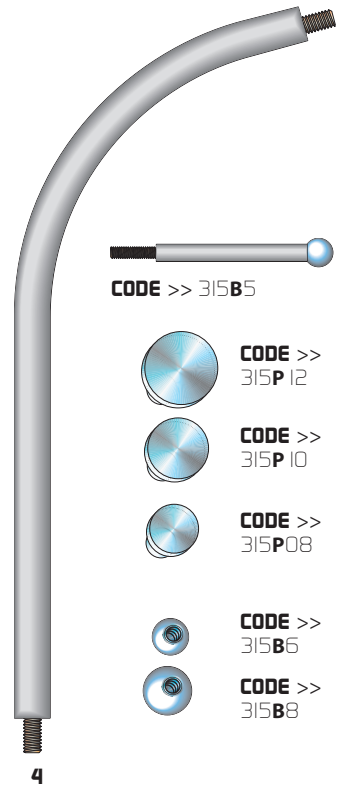

CODE >> 315B5



CODE >> 315P12



CODE >> 315P10



CODE >> 315P08



CODE >> 315B6



CODE >> 315B8

+44 (0) 1258 471 770
+44 (0) 1258 471 772



Meditech Systems Limited
Unit 3 Richmar
Butt's Pond Ind.Estate
Sturminster Newton
Dorset DT10 1AZ



FOR ALL ORDERS CALL DIRECT **0700 - 4 - MEDITECH**

PATIENT PLATE CABLES

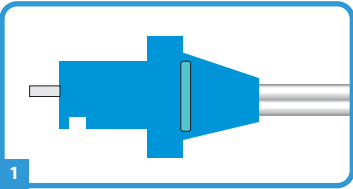

CABLE LENGTH METRES

3m CODE >> 902213025

5m CODE >> 902215025

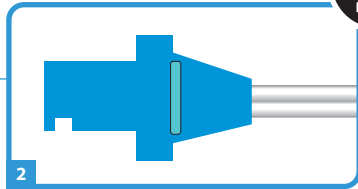

CABLE LENGTH METRES

3m CODE >> 902203025

5m CODE >> 902205025

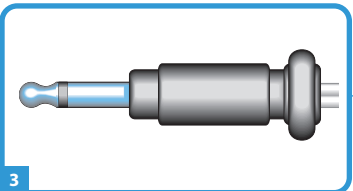

CABLE LENGTH METRES

3m CODE >> 906403025

5m CODE >> 906405025

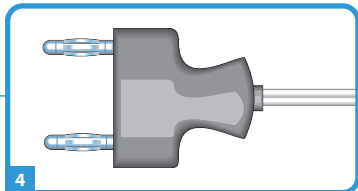

CABLE LENGTH METRES

3m CODE >> 904403025

5m CODE >> 904405025

2 single use option
please use prefix SU

wherever you see this logo
please note that you have
the option of single-use on
the products shown

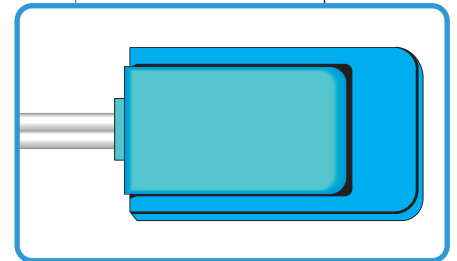

PATIENT PLATE
CLAMP CONNECTION

FOOT PEDALS

- Low profile
- Fully sealed
- Durable cable
- Non slip

**FOOT PEDALS
AVAILABLE FOR
ALL GENERATORS
ON REQUEST**

GENERATOR CONNECTIONS

- 1. Valleylab style
- 2. Valleylab without pin
- 3. 6.4mm jack plug
- 4. Twin 4mm pins

SPLIT PLATE (ADULT)
CODE >> 901101

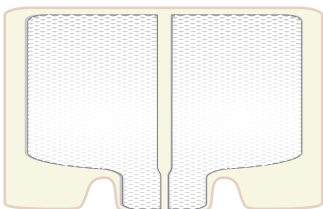

SINGLE PLATE (ADULT)
CODE >> 901001



STANDARD SPLIT PLATE
& CABLE (ADULT)
CODE >> 901102

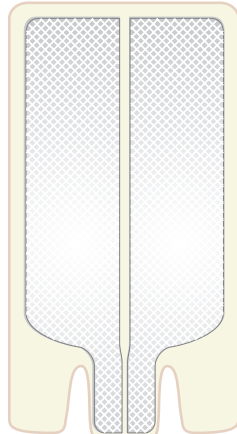

SINGLE PLATE & CABLE
(ADULT)
CODE >> 90103001

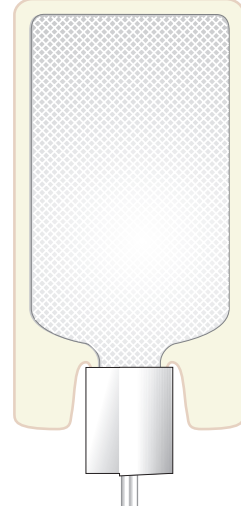

FOR ALL ORDERS CALL DIRECT **0700 - 4 - MEDITECH**

meditech
systems limited

Meditech Systems Limited
Unit 3 Richmond
Butt's Pond Industrial Estate
Sturminster Newton
Dorset DT10 1AZ

Tel: +44 (0) 1258 471 770
Fax: +44 (0) 1258 471 772

10 >>

Cables monopolar

GENERATOR

4MM PIN CONNECTION >>

Generators: Berchtold, Erbe, Martin & Eschmann

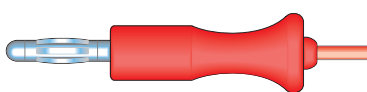

3m
5m
AVAILABLE IN
3 & 5 METRE
LENGTH CABLES

INSTRUMENT END CONNECTIONS

cable length metres	SOCKET	SOCKET	SOCKET	SNARE	1.95MM PIN
	4.8	4.0	3.0	3.0	
3m	10403048	10403040	10403030	10403028	104030195
5m	10405048	10405040	10405030	10405028	104050195
FRONT & SIDE VIEWS OF INSTRUMENT END CONNECTIONS	OLSEN	STORZ	STORZ	4MM PIN	
	10403042 10405042	10403010 10405010	10403011 10405011	10403044 10405044	

GENERATOR

HOOK CONNECTION >>

Generators: (Older generators)



3m
5m
AVAILABLE IN
3 & 5 METRE
LENGTH CABLES

INSTRUMENT END CONNECTIONS

cable length metres	SOCKET	SOCKET	SOCKET	SNARE	1.95MM PIN
	4.8	4.0	3.0	3.0	
3m	10303048	10303040	10303030	10303028	103030195
5m	10305048	10305040	10305030	10305028	103050195
FRONT & SIDE VIEWS OF INSTRUMENT END CONNECTIONS	OLSEN	STORZ	STORZ	4MM PIN	
	10303042 10305042	10303010 10305010	10303011 10305011	10303044 10305044	

GENERATOR

8MM BOVIE CONNECTION >>

Generators: Valleylab, Erbe & Bovie

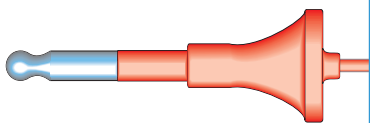

3m
5m
AVAILABLE IN
3 & 5 METRE
LENGTH CABLES

INSTRUMENT END CONNECTIONS

cable length metres	SOCKET	SOCKET	SOCKET	SNARE	1.95MM PIN
	4.8	4.0	3.0	3.0	
3m	10803048	10803040	10803030	10803028	108030195
5m	10805048	10805040	10805030	10805028	108050195
FRONT & SIDE VIEWS OF INSTRUMENT END CONNECTIONS	OLSEN	STORZ	STORZ	4MM PIN	
	10803042 10805042	10803010 10805010	10803011 10805011	10803044 10805044	

+44 (0) 1258 471 770
+44 (0) 1258 471 772

TEL: 00
FAX: 00

GENERATOR		INSTRUMENT END CONNECTIONS					
5MM PIN CONNECTION >> Generators: Berchtold, Erbe, Martin & Eschmann		cable length metres 3m 5m	SOCKET 4.8 10503048 10505048	SOCKET 4.0 10503040 10505040	SOCKET 3.0 10503030 10505030	SNARE 3.0 10503028 10505028	1.95MM PIN 105030195 105050195
AVAILABLE IN 3 & 5 METRE LENGTH CABLES		FRONT & SIDE VIEWS OF INSTRUMENT END CONNECTIONS	OLSEN 10503042 10505042	STORZ 10503010 10505010	STORZ 10503011 10505011	4MM PIN 10503044 10505044	

S-CORD CABLES

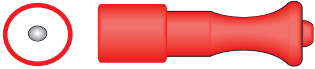
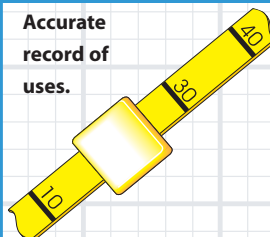
GENERATOR	INSTRUMENT END CONNECTIONS			CLICK COUNTER
 S-CORD >> endoscopic earthing cables for valleylab generators for use in endoscopy	Olympus screw-fit for connecting short pin cable length metres 1m SOCKET 4.8 10401097	Same long pin SOCKET 3.0 10401098	Pentax screw-fit 4MM PIN 10401099	Accurate record of uses. 

ADAPTORS

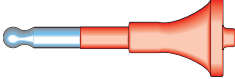
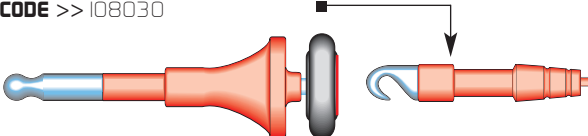
GENERATOR ADAPTORS	
 8MM BOVIE CONNECTION >> with 4mm socket CODE >> 108040	 CODE >> 108030 8mm Bovie connection with hook screw attachment

CODING FORMAT EXAMPLE

CABLE LENGTH: 3.0 METRES

1 0 4 0 3 0 4 8

MONOPOLAR CABLES GENERATOR CONNECTION PIN SIZE CABLE LENGTH INSTRUMENT CONNECTION SOCKET STYLE

2 single use option please use prefix SU for single use

FOR ALL ORDERS CALL DIRECT 0700 - 4 - MEDITECH

12 >>

Cables bipolar

GENERATOR

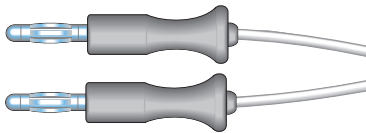

TWIN 4MM PINS >>
compatible with most generators

INSTRUMENT END CONNECTIONS

	EURO	STORZ	WOLF	US	AESCLAP (OLD)
3m	11443075	11443041	11443042	11443076	11443043
5m	11445075	11445041	11445042	11445076	11445043

GENERATOR



COAXIAL PIN >>
Generators: Erbe, Downs & Siemens

INSTRUMENT END CONNECTIONS

	EURO	STORZ	WOLF	US	AESCLAP (OLD)
3m	11423075	11423041	11423042	11423076	11423043
5m	11425075	11425041	11425042	11425076	11425043

GENERATOR



COAXIAL PIN >>
Generators: Berchtold, Wolf, & Martin

INSTRUMENT END CONNECTIONS

	EURO	STORZ	WOLF	US	AESCLAP (OLD)
3m	11453075	11453041	11453042	11453076	11453043
5m	11455075	11455041	11455042	11455076	11455043

GENERATOR

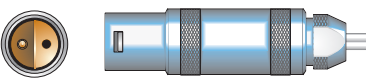

LEMO CONNECTOR >>
Generators: Older Eschmann (Iemo)

INSTRUMENT END CONNECTIONS

	EURO	STORZ	WOLF	US	AESCLAP (OLD)
3m	11433075	11433041	11433042	11433076	11433043
5m	11435075	11435041	11435042	11435076	11435043

FOR ALL ORDERS CALL DIRECT **0700 - 4 - MEDITECH**

TEL No +44 (0) 1258 471 770
FAX No +44 (0) 1258 471 772

Meditech Systems Limited
Unit 3 Richmar
Butt's Pond Ind.Estate
Sturminster Newton
Dorset DT10 1AZ



GENERATOR

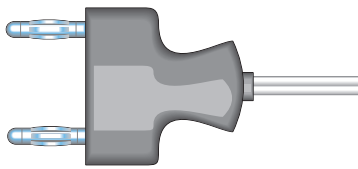

FIXED 4MM PINS >>
Generators: Emc, Dolley

INSTRUMENT END CONNECTIONS

Length	EURO	STORZ	WOLF	US	AESCULAP (OLD)
3m	11483075	11483041	11483042	11483076	11483043
5m	11485075	11485041	11485042	11485076	11485043

GENERATOR

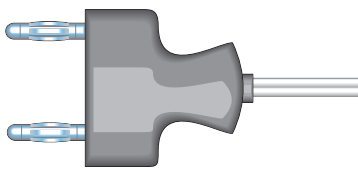

FIXED 4MM PINS >>
Generators: Valleylab, Lamidey

INSTRUMENT END CONNECTIONS

Length	EURO	STORZ	WOLF	US	AESCULAP (OLD)
3m	11473075	11473041	11473042	11473076	11473043
5m	11475075	11475041	11475042	11475076	11475043

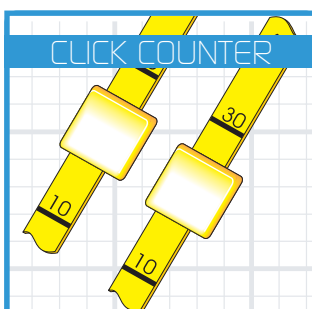

CLICK COUNTER:
Advance marker one CLICK each time product is processed (cannot be reversed)

ACCURATE RECORD:
Easily visible scale shows accurate processing record

FLEXIBLE SYSTEM:
Easily attached to a wide range of devices

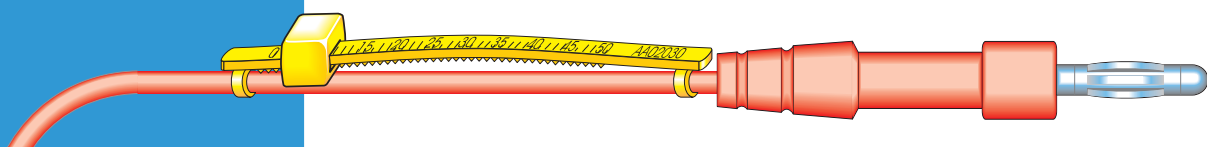

CODING FORMAT EXAMPLE

CABLE LENGTH: 5.0 metres

1 1 4 3 5 0 7 5

- 1 1: PREFIX BIPOLAR CABLES
- 4 3: GENERATOR CONNECTION
- 5 0 7 5: INSTRUMENT CONNECTION SOCKET STYLE

2 single use option please use prefix SU

wherever you see this logo please note that you have the option of single-use on the products shown

meditech
systems limited

Meditech Systems Limited
Unit 3 Richmond
Butt's Pond Industrial Estate
Sturminster Newton
Dorset DT10 1AZ

Tel: +44 (0) 1258 471 770
Fax: +44 (0) 1258 471 772

14 >>

Bipolar forceps

STRAIGHT FORCEPS



1 STRAIGHT STANDARD PATTERN 180mm



2 STRAIGHT STANDARD PATTERN 200mm



3 STRAIGHT STANDARD PATTERN 230mm



4 STRAIGHT ADSON PATTERN 150mm



5 STRAIGHT ADSON PATTERN 130mm

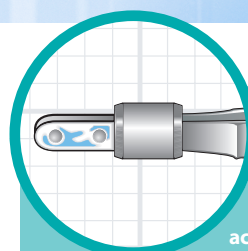

BLOCK FEATURES

■ **MOULDED BLOCK:**
forceps legs insert moulded to provide accurate spring tension.

■ **COLOUR CODED:**

if required moulding can be colour coded

■ **QUALITY FINISH:**

over moulding provides double insulation feature between block & legs.

STRAIGHT FORCEPS



6 STRAIGHT CAWTHORNE PATTERN 80mm



7 STRAIGHT CAWTHORNE PATTERN 110mm



8 STRAIGHT STANDARD PATTERN 110mm



9 STRAIGHT STANDARD PATTERN 130mm



10 STRAIGHT STANDARD PATTERN 150mm

TIP STYLES

1 **PLAIN**
polished stainless steel

2 **TOOTHED (K)**
Kocher style single toothed

3 **SERRATED (S)**
fine toothed edge.

tip size

6-8mm

- | | |
|----------------------------|-----------------------------|
| 1 >> CODE 7710180UK | 6 >> CODE 761080UK |
| 2 >> CODE 7710200UK | 7 >> CODE 7610110UK |
| 3 >> CODE 7710230UK | 8 >> CODE 7710110UK |
| 4 >> CODE 7910150UK | 9 >> CODE 7710130UK |
| 5 >> CODE 7910130UK | 10 >> CODE 7710150UK |

REUSABLE BIPOLAR FORCEPS

STYLE	LENGTH	TIP SIZES		
		2MM	1MM	0.5MM
STRAIGHT				
Cawthorne	80mm	7620080UK	7610080UK	7605080UK
Cawthorne	110mm	7620110UK	7610110UK	7605110UK
Standard pattern	110mm	7720110UK	7710110UK	7705110UK
Standard pattern	130mm	7720130UK	7710130UK	7705130UK
Standard pattern	150mm	7720150UK	7710150UK	7705150UK
Standard pattern	180mm	7720180UK	7710180UK	7705180UK
Standard pattern	200mm	7720200UK	7710200UK	7705200UK
Adson pattern	130mm	7920130UK	7910130UK	7905130UK
Adson pattern	150mm	7920150UK	7910150UK	7905150UK

PLEASE NOTE:

for US two pin fitting replace UK with US(eg 762080US)
for serrated tips add the letter 'S' (eg 7620080UKS) K= toothed tip

CODING FORMAT EXAMPLE

OVERALL LENGTH: 180mm



7710180UK

BIPOLAR FORCEPS TIP SIZE CABLE CONNECTION

FORCEPS STYLE OVERALL LENGTH

NB: K= toothed tip S= serrated tip

+44 (0) 1258 471 770
+44 (0) 1258 471 772



Meditech Systems Limited
Unit 3 Richmar
Butt's Pond Ind.Estate
Sturminster Newton
Dorset DT10 1AZ



FOR ALL ORDERS CALL DIRECT 0700 - 4 - MEDITECH

ANGLED FORCEPS



1 ANGLED STANDARD PATTERN 200mm



2 ANGLED STANDARD PATTERN 180mm



3 ANGLED STANDARD PATTERN 150mm



4 ANGLED STANDARD PATTERN 130mm



5 ANGLED STANDARD PATTERN 110mm

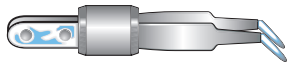

6 ANGLED CAWTHORNE PATTERN 80mm

1 >> CODE 7510200UK

5 >> CODE 7510110UK

2 >> CODE 7510180UK

6 >> CODE 7510800UK

3 >> CODE 7510150UK

7 >> CODE 7810150UK

4 >> CODE 7510130UK

8 >> CODE 7810200UK

2 single use option
please use prefix SU

BIPOLAR FORCEPS

STYLE	LENGTH	TIP SIZES		
		2MM	1MM	0.5MM
Angled				
Bayonet	150mm	7820150UK	7810150UK	7805150UK
Bayonet	200mm	7820200UK	7810200UK	7805200UK
Angled tip	80mm	7520080UK	7510080UK	7505080UK
Angled tip	110mm	7520110UK	7510110UK	7505110UK
Angled tip	130mm	7520130UK	7510130UK	7505130UK
Angled tip	150mm	7520150UK	7510150UK	7505150UK
Angled tip	180mm	7520180UK	7510180UK	7505180UK
Angled tip	200mm	7520200UK	7510200UK	7505200UK
Angled tip	230mm	7520230UK	7510230UK	7505230UK

PLEASE NOTE:
for US two pin fitting replace UK with US (eg 762080US)
for serrated tips add the letter 'S' (eg 7620080UKS) K= toothed tip

COLOUR CODED SYSTEM

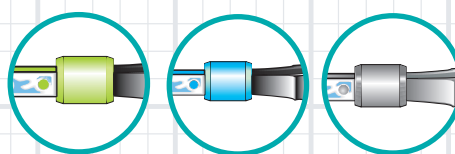

Due to our unique method of moulding the forceps block, we are able to offer colour coding possibilities to customer requirements.

Example:

- TRACEABILITY: departmental etc
- TIP SIZE INDICATOR:

BAYONET FORCEPS

ANGLED FEATURES

With the use of bipolar forceps in many new surgical disciplines. Forceps design is critical so that the instrument shape meets the procedure requirements. We are able to offer custom designs as well as those shown.

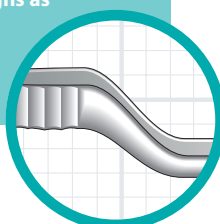

7 BAYONET STYLE 150MM

8 BAYONET STYLE 200MM

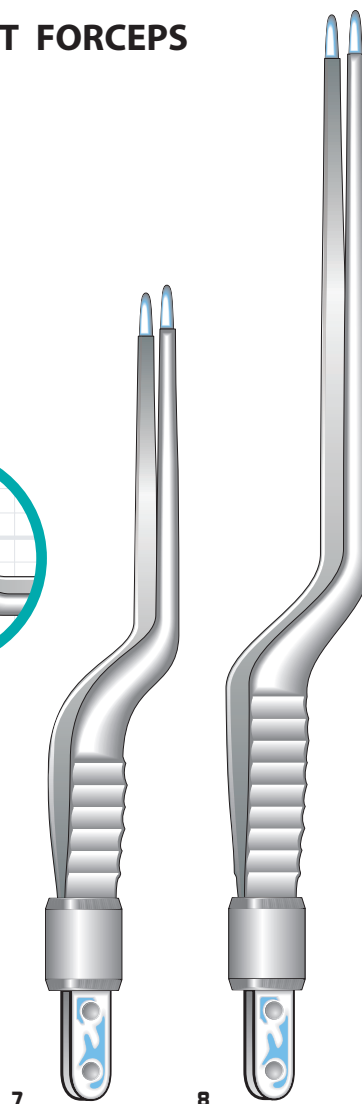

meditech
systems limited

Meditech Systems Limited
Unit 3 Richmond
Butt's Pond Ind Estate
Sturminster Newton
Dorset DT10 1AZ

Tel: +44 (0) 1258 471 770
Fax: +44 (0) 1258 471 772

16 >>

Disposable bipolar forceps

SINGLE USE FORCEPS

INTEGRAL CABLE

■ Cost effective

FORCEPS LEG

Stainless steel

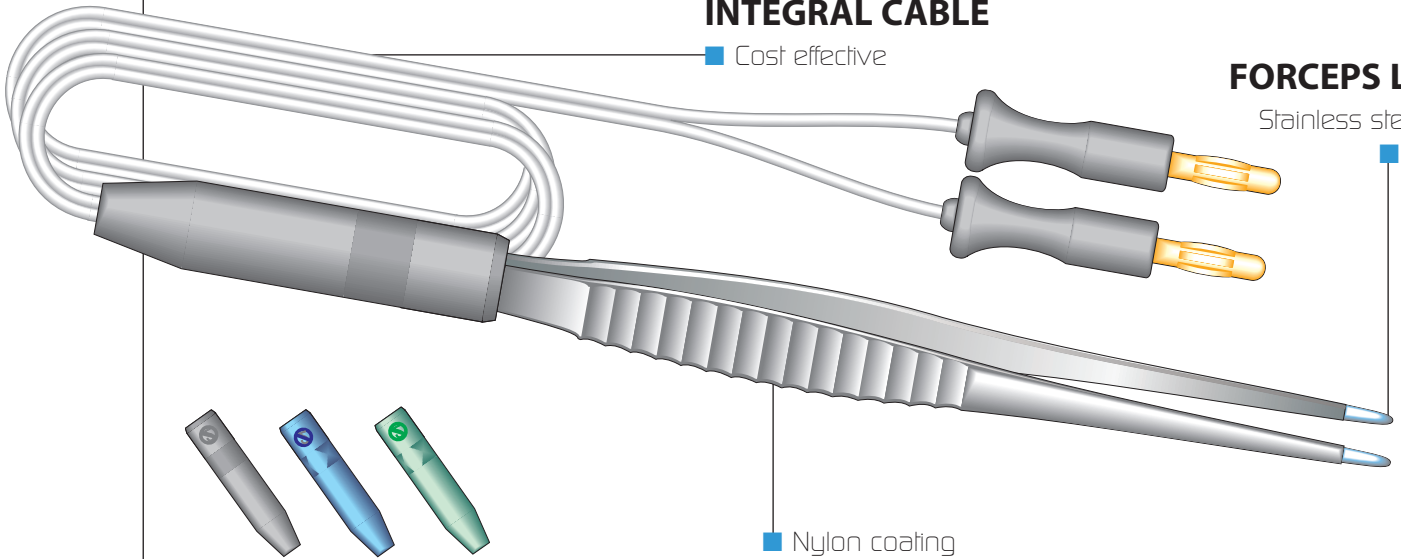

■ Nylon coating

TIP SIZES COLOUR CODED

FEATURES:

STAINLESS STEEL LEGS

■ Providing same feel as reusable

NYLON COATING

■ Same insulation as reusable

INTEGRAL CABLE

■ Cost effective, choice of pins

SINGLE USE BIPOLAR FORCEPS

STYLE	LENGTH	TIP SIZES		
		2MM	1MM	0.5MM
STRAIGHT				
Cawthorne	80mm	su762008044	su761008044	su760508044*
Cawthorne	110mm	su762011044	su761011044	su760511044
Standard pattern	110mm	su772011044	su771011044	su770511044
Standard pattern	130mm	su772013044	su771013044	su770513044
Standard pattern	150mm	su772015044	su771015044	su770515044
Standard pattern	180mm	su772018044	su771018044	su770518044
Standard pattern	200mm	su772020044	su771020044	su770520044
Adson pattern	130mm	su792013044	su791013044	su790513044
Adson pattern	150mm	su792015044	su791015044	su790515044

·PLEASE NOTE:

for Kocher tooth tips add the letter "K" (eg 762008044K)

for serrated tips add the letter "S" (eg 762008044S)

STYLE	LENGTH	TIP SIZES		
		2MM	1MM	0.5MM
ANGLED				
Bayonet	150mm	su782015044	su781015044	su780515044
Bayonet	200mm	su782020044	su781020044	su780520044
Angled tip	80mm	su752008044	su751008044	su750508044
Angled tip	110mm	su752011044	su751011044	su750511044
Angled tip	130mm	su752013044	su751013044	su750513044
Angled tip	150mm	su752015044	su751015044	su750515044
Angled tip	180mm	su752018044	su751018044	su750518044
Angled tip	200mm	su752020044	su751020044	su750520044

·PLEASE NOTE:

for Kocher tooth tips add the letter "K" (eg 762008044K)

for serrated tips add the letter "S" (eg 762008044S)

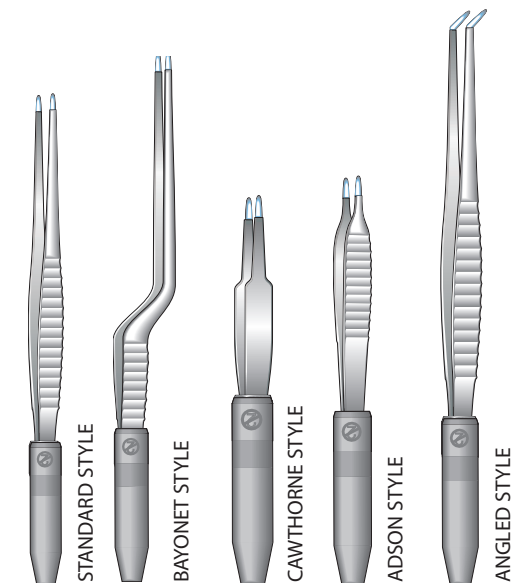

+44 (0) 1258 471 770
+44 (0) 1258 471 772

TEL: 01258 471 770
FAX: 01258 471 772

Meditech Systems Limited
Unit 3 Richmar
Butt's Pond Ind.Estate
Sturminster Newton
Dorset DT10 1AZ

meditech
systems limited

FOR ALL ORDERS CALL DIRECT 0700 - 4 - MEDITECH

"INSU-TIP" FORCEPS

FEATURES:

INSULATED TIP

■ Outer surfaces of tips are insulated to prevent burning to peripheral tissue

INSULATED TIP

■ 70% reduction of exposed metal on tips.

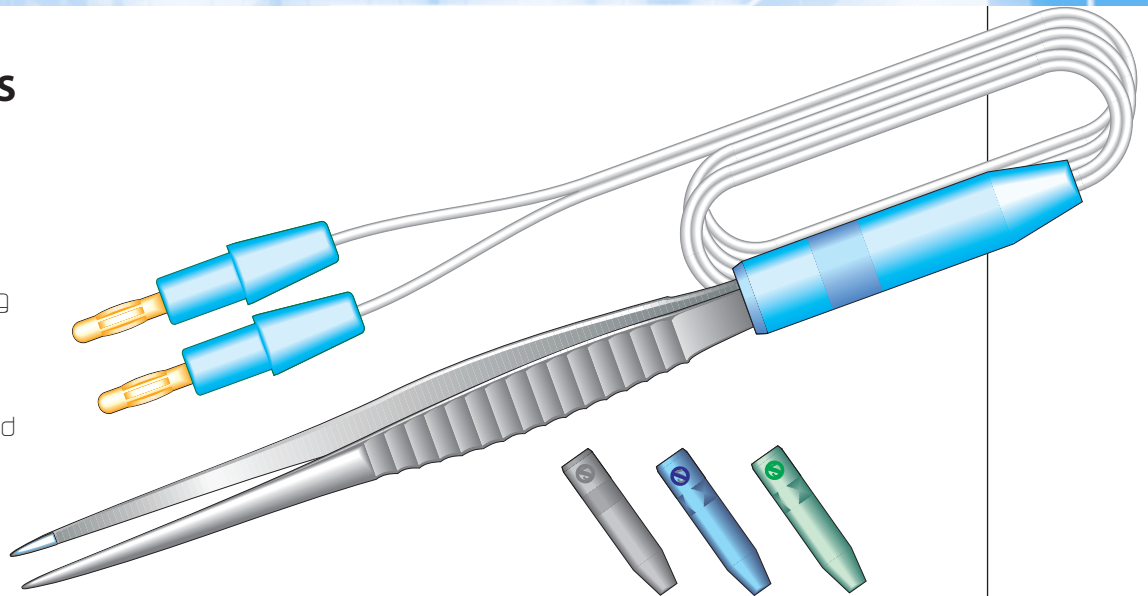

INSULATED TIP

■ Energy focused between tips allowing lower power setting to be used

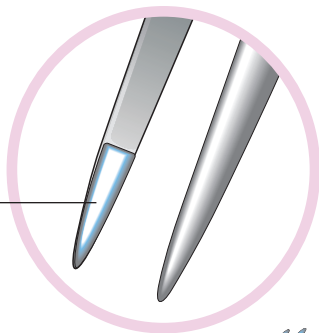

TIP SIZES COLOUR CODED

"INSU-TIP" BIPOLAR FORCEPS				
STYLE	LENGTH	TIP SIZES		
		2MM	1MM	0.5MM
STRAIGHT				
Cawthorne	80mm	su862008044	su861008044	su860508044*
Cawthorne	110mm	su862011044	su861011044	su860511044
Standard pattern	110mm	su872011044	su871011044	su870511044
Standard pattern	130mm	su872013044	su871013044	su870513044
Standard pattern	150mm	su872015044	su871015044	su870515044
Standard pattern	180mm	su872018044	su871018044	su870518044
Standard pattern	200mm	su872020044	su871020044	su870520044
Adson pattern	130mm	su892013044	su891013044	su890513044
Adson pattern	150mm	su892015044	su891015044	su890515044
*PLEASE NOTE: for Kocher tooth tips add the letter "K" (eg 762008044K) for serrated tips add the letter "S" (eg 762008044S)				
STYLE	LENGTH	TIP SIZES		
		2MM	1MM	0.5MM
ANGLED				
Bayonet	150mm	su882015044	su881015044	su880515044
Bayonet	200mm	su882020044	su881020044	su880520044
Angled tip	80mm	su852008044	su851008044	su850508044
Angled tip	110mm	su852011044	su851011044	su850511044
Angled tip	130mm	su852013044	su851013044	su850513044
Angled tip	150mm	su852015044	su851015044	su850515044
Angled tip	180mm	su852018044	su851018044	su850518044
Angled tip	200mm	su852020044	su851020044	su850520044
*PLEASE NOTE: for Kocher tooth tips add the letter "K" (eg 762008044K) for serrated tips add the letter "S" (eg 762008044S)				

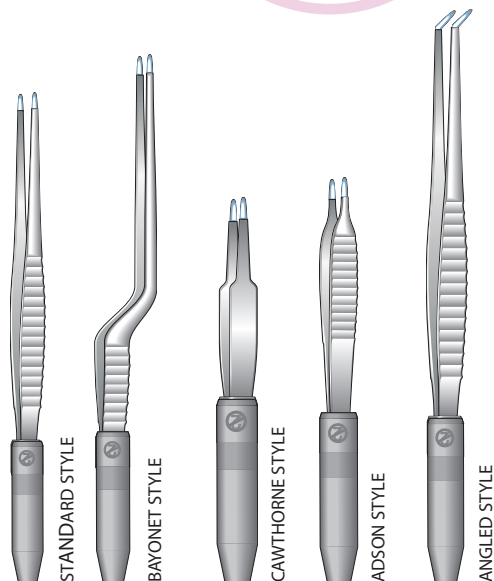

18 >>

Monopolar forceps

REUSABLE FORCEPS



REMINGTON HOBBS **CODE 1mm >> 671023048 2mm >> 672023048**

CODING FORMAT EXAMPLE

OVERALL LENGTH: 180mm

6 7 1 0 1 8 0 4 8

MONO POLAR FORCEPS TIP SIZE (0.1MM) CABLE CONNECTION (0.1mm)

FORCEPS STYLE OVERALL LENGTH (mm)



STANDARD
CODE 1mm >> 671020048 2mm >> 672020048



STANDARD
CODE 1mm >> 651018048 2mm >> 652018048



STANDARD
CODE 1mm >> 671015048 2mm >> 672015048



ADSON
CODE 1mm >> 691013048 2mm >> 692013048



BAYONET (200mm)
CODE 1mm >> 681020048 2mm >> 682020048
BAYONET (150mm)
CODE 1mm >> 681015048 2mm >> 682015048



MCINDOE
CODE 1mm >> 641015048 2mm >> 642015048

SINGLE USE WITH CABLE



MCINDOE
CODE 1mm >> SU641015040 2mm >> SU642015040



STANDARD
CODE 1mm >> SU671020040 2mm >> SU672020040



STANDARD
CODE 1mm >> SU671018040 2mm >> SU672018040



STANDARD
CODE 1mm >> SU671015040 2mm >> SU672015040



STANDARD
CODE 1mm >> SU671013040 2mm >> SU672013040



BAYONET (200mm)
CODE 1mm >> SU681020040 2mm >> SU682020040

BAYONET (150mm)
CODE 1mm >> SU681015040 2mm >> SU682015040



CODING FORMAT EXAMPLE

S U 6 7 1 0 1 8 0 4 0

MONO POLAR FORCEPS TIP SIZE (0.1MM) CABLE CONNECTION (0.1MM)

FORCEPS STYLE OVERALL LENGTH (MM)

NB: K= toothed tip S= serrated tip

+44 (0) 1258 471 770
+44 (0) 1258 471 772

TEL: 01258 471770
FAX: 01258 471772

Meditech Systems Limited
Unit 3 Richmar
Butt's Pond Ind. Estate
Sturminster Newton
Dorset DT10 1AZ

meditech
systems limited

FOR ALL ORDERS CALL DIRECT 0700 - 4 - MEDITECH

FORCEPS & SCISSORS

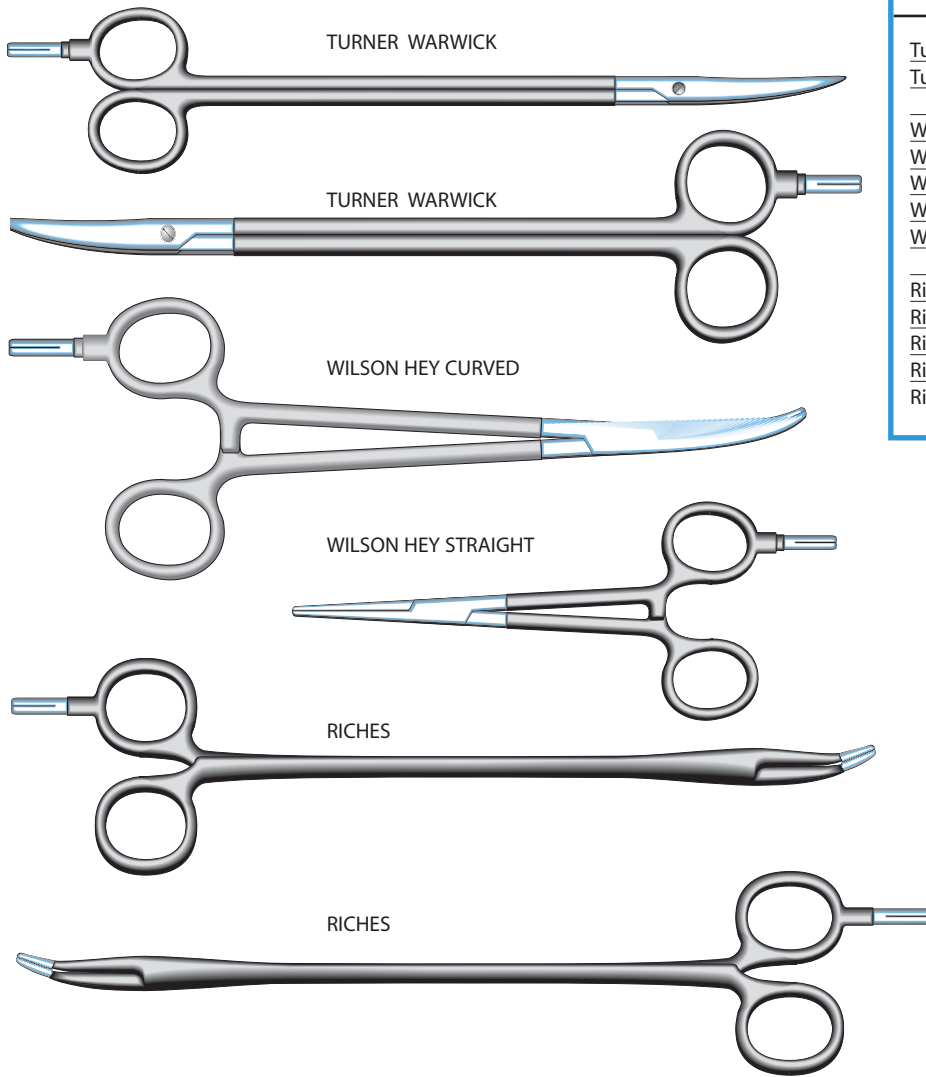

MONOPOLAR FORCEPS & SCISSORS

STYLE	LENGTH	CODE	
		STRAIGHT	CURVED
Turner Warwick	180mm	601800	601801
Turner Warwick	240mm	602400	602401
Wilson Hey	130mm	611300	611301
Wilson Hey	150mm	611500	611501
Wilson Hey	180mm	611800	611801
Wilson Hey	200mm	612000	612001
Wilson Hey	230mm	612300	612301
Riches	130mm		621301
Riches	150mm		621501
Riches	180mm		621801
Riches	200mm		622001
Riches	230mm		622301

FOOT PEDALS

- Low profile
- Fully sealed
- Durable cable
- Non slip

FOOT PEDALS AVAILABLE FOR ALL GENERATORS ON REQUEST

meditech
systems limited

Meditech Systems Limited
Unit 3 Richmond
Butt's Pond Industrial Estate
Sturminster Newton
Dorset DT10 1AZ

TRACEABILITY SYSTEMS

INDIVIDUAL REFERENCE NUMBER:

- allows recording of instrument re-processing
- individual department logging
- co-ordinated with re-insulation service on instrument
- instrument record cards (archive file)

RE-INSULATION REPAIR SERVICE



RE-INSULATION REPAIR SERVICE

Tel: +44 (0) 1258 471 770
Fax: +44 (0) 1258 471 772

20 >>

Loop & ball electrodes

FRAME & WIRE DESIGN

<p>SQUARE</p>	<p>LOW-PROFILE</p>	<p>T-BAR</p>
<p>FRAME DESIGN</p> <ul style="list-style-type: none"> ■ sturdy ■ stainless steel precision finish ■ dual insulation <p>WIRE</p> <ul style="list-style-type: none"> ■ stainless steel or tungsten ■ 0.25mm dia 	<p>STANDARD</p>	<p>SAIL</p>

STANDARD FRAME DESIGN

DIA 10mm CODE >> 3024130L10

DIA 15mm CODE >> 3024130L15

DIA 20mm CODE >> 3024130L20

DIA 25mm CODE >> 3024130L25

"FLEXI-SHAFT" AVAILABLE ON ALL DESIGNS

"FLEXI-SHAFT" CODE >> 3324200B5NS
 prefix code with 33 for all "flexi-shaft" products

SQUARE FRAME DESIGN

FRAME 10mm CODE >> 3024130SQ10

FRAME 12mm CODE >> 3024130SQ12

FRAME 18mm CODE >> 3024130SQ18

FRAME 20mm CODE >> 3024130SQ20

FRAME 22mm CODE >> 3024130SQ22

CODING FORMAT EXAMPLE

OVERALL LENGTH: 130mm

3024130L15

3	0	2	4	1	3	0	L	1	5
PREFIX COLPOSCOPY		OVERALL LENGTH (mm)			SHAFT DIA (0.1mm)		*STYLE FRAME	LOOP DIA (mm)	

*L = standard LP = low profile
 SQ = square T = t-bar B = ball SA = sail

2 single use option
 please use prefix SU

TEL +44 (0) 1258 471 770
 FAX +44 (0) 1258 471 772

Meditech Systems Limited
 Unit 3 Richmar
 Butt's Pond Ind.Estate
 Sturminster Newton
 Dorset DT10 1AZ



FOR ALL ORDERS CALL DIRECT 0700 - 4 - MEDITECH

T-BAR FRAME DESIGN

FRAME 12mm CODE >> 3024I30T12



FRAME 18mm CODE >> 3024I30T18



FRAME 20mm CODE >> 3024I30T20

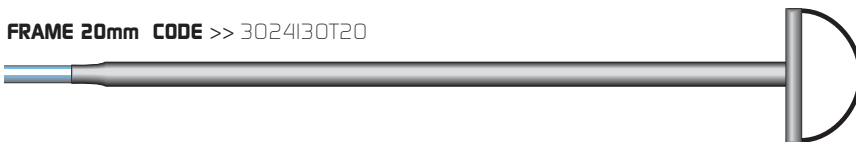

FRAME 22mm CODE >> 3024I30T22

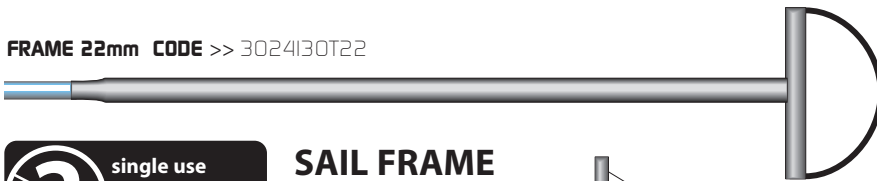

2 single use option please use prefix SU

SAIL FRAME DESIGN

FRAME 15mm CODE >> 3024I30SA15

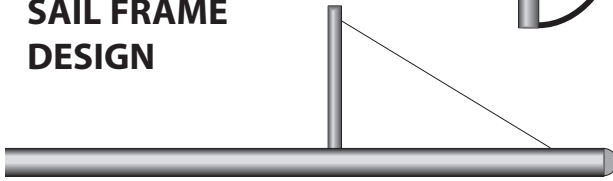

FRAME 12mm CODE >> 3024I30SA12



FRAME 8mm CODE >> 3024I30SA08



BALL ELECTRODE FEATURES

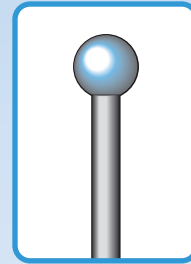

- High quality stainless steel ball
- Non-stick coating available
- High quality stainless steel shaft
- Double insulation to shaft
- "Flexi - shaft" available

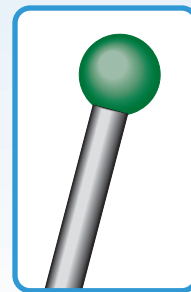

"NON-STICK"

BALL ELECTRODES

BALL 3mm CODE >> 3024I30B3



BALL 4mm CODE >> 3024I30B4



BALL 6mm CODE >> 3024I30B6



BALL 8mm CODE >> 3024I30B8



meditech
Systems Limited

Meditech Systems Limited
Unit 3 Richmond
Butt's Pond Industrial Estate
Sturminster Newton
Dorset DT10 1AZ

Tel: +44 (0) 1258 471 770
Fax: +44 (0) 1258 471 772

Tel: +44 (0) 1258 471 770
Fax: +44 (0) 1258 471 772

22 >>

Gynaecology instruments

CUSCO SPECULUM

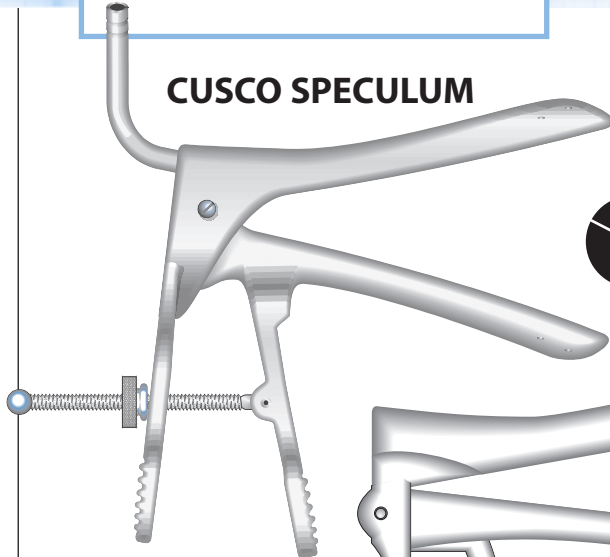

2 single use option
please use prefix SU

WINTERTON STYLE
CODE >> 32016

CODE >> SU61102

SIMS SPECULUM
CODE >> 33011

LANGDEN SPECULUM



CODE >> 35011

CODE >> 61124FL

SMOKE EVACUATION

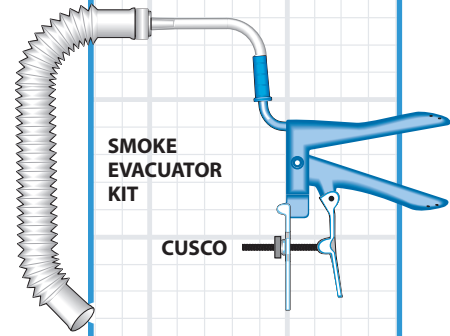

SMOKE EVACUATOR KIT

CUSCO

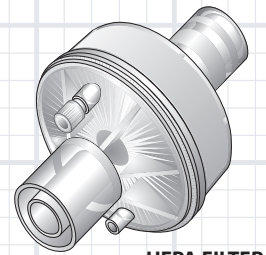

HEPA FILTER

Disposable kits for smoke evacuation available with or without HEPA filter. Also available portable smoke evacuator

SPECULUM DESIGNS

PRODUCT INSULATED NON-INSULATED SIZE

*insulated with smoke tube

PRODUCT	INSULATED	NON-INSULATED	SIZE
CUSCO	32010*	61100	SMALL
	32011*	61102	MEDIUM
	32012*	61104	LARGE
	32013*	61103	MED LONG
	32016*	61106	X LARGE
SIMS	33010	61140	SMALL
	33011	61142	MEDIUM
	33012	61144	LARGE
GRAVES	34010	61120	SMALL
	34011	61122	MEDIUM
	34012	61124	LARGE
LANGDEN	35010	61120	SMALL
	35011	61122	MEDIUM
	35012	61124	LARGE
CUSCO	SU32010		SMALL
	SU32011		MEDIUM
	SU32012		LARGE

RE-INSULATION REPAIR SERVICE



RE-INSULATION REPAIR SERVICE

+44 (0) 1258 471 770
+44 (0) 1258 471 772

TEL
FAX

Meditech Systems Limited
Unit 3 Richmar
Butt's Pond Ind.Estate
Sturminster Newton
Dorset DT10 1AZ

meditech
systems limited

FOR ALL ORDERS CALL DIRECT **0700 - 4 - MEDITECH**

TISCHLER MORGAN

CODE >> 5720021

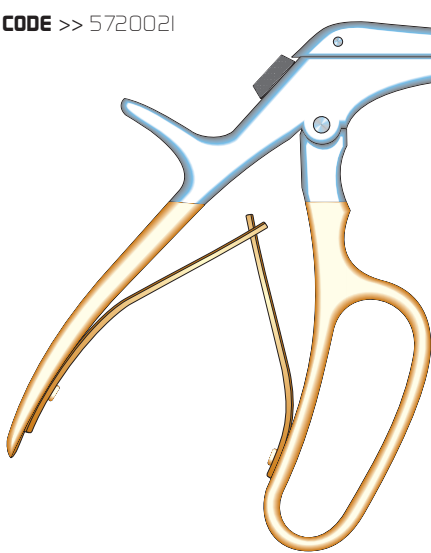

FEATURES

- high quality stainless steel
- precision biopsy head
- durability

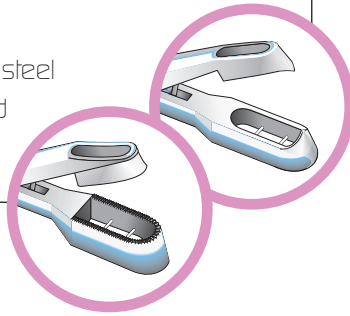

EPPENDORFER

CODE >> 5720022 (200mm)

CODE >> 5722022 (220mm)

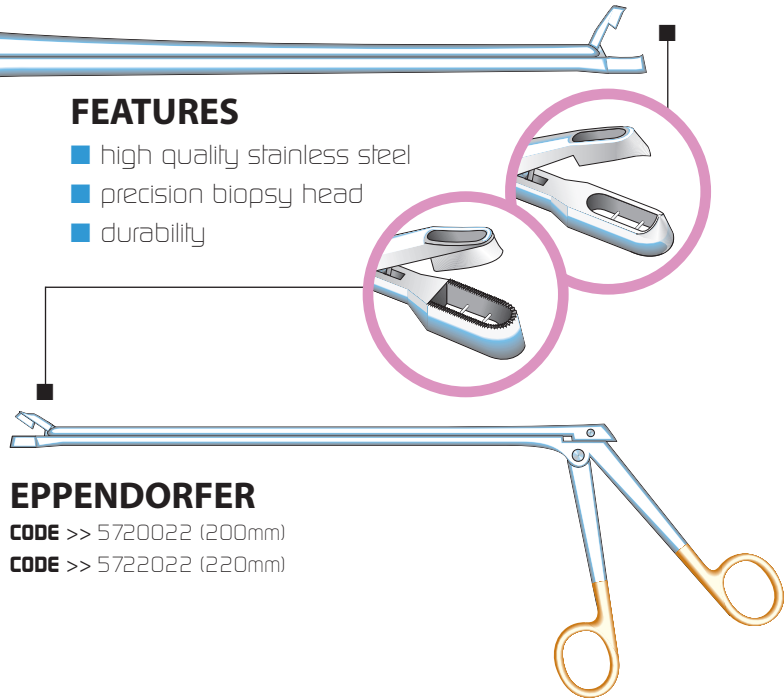

ROTATIONAL BIOPSY PUNCH

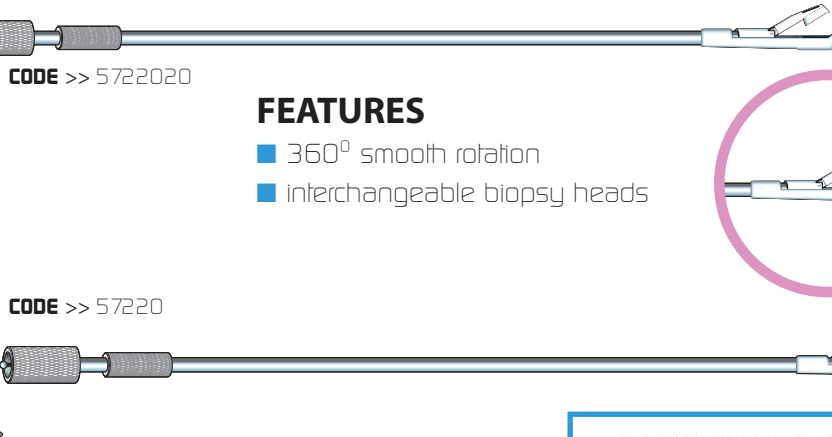

CODE >> 5722020

FEATURES

- 360° smooth rotation
- interchangeable biopsy heads

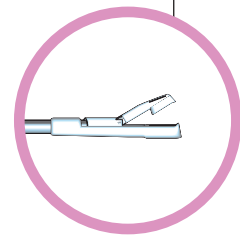

CODE >> 57220

CODE >> 572H

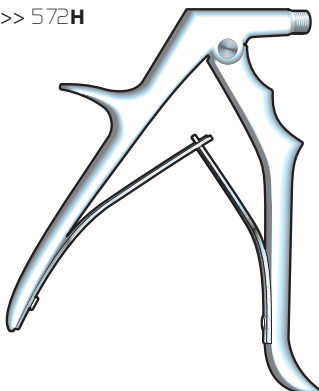

wherever you see this logo please note that you have the option of single-use on products shown

2 single use option please use prefix SU for single use

ROTATIONAL BIOPSY PUNCH

STYLE	CODE	SHAFT
TISCHLER MORGAN	5721120	200mm
	5721122	220mm
MINI TISCHLER	5721220	200mm
	5721222	220mm

OTHER SIZES AVAILABLE ON REQUEST

24 >>

ENT instruments
Laryngoscopes

BLACKENED RANGE

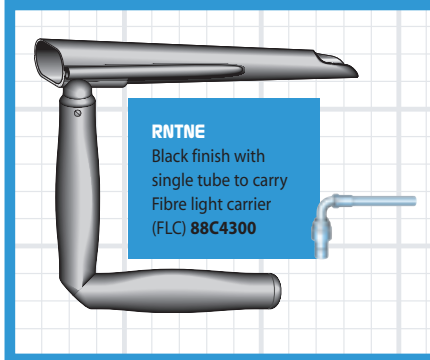

RNTNE
Black finish with single tube to carry Fibre light carrier (FLC) **88C4300**

R.N.T.N.E.

SIZE	SIZES	CODE
small	proximal-20mm x15mm distal-15mm x11mm effective length-120mm	885602
med	proximal-24mm x15mm distal-15.5mm x11mm effective length-150mm	885603
large	proximal-28mm x19mm distal-18mm x13mm effective length-152mm	885604

PLEASE NOTE:
RNTNE- Royal National throat, nose & ear hospital

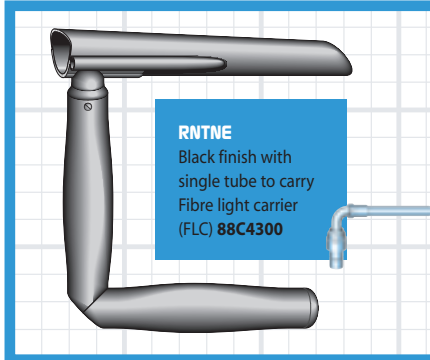

RNTNE
Black finish with single tube to carry Fibre light carrier (FLC) **88C4300**

ANTERIOR COMMISSURE (AC)

SIZE	SIZES	CODE
small	proximal-21mm x19mm distal-15mm x14mm effective length-123mm	885599
med	proximal-22mm x20mm distal-15mm x14mm effective length-149mm	885600
large	proximal-28mm x26mm distal-18mm x15mm effective length-149mm	885601

PLEASE NOTE:
RNTNE- Royal National throat, nose & ear hospital

RHYS-EVANS MICRO LARYNGOSCOPE

CODE >> 885613
Black finish for laser surgery with twin side tubes to carry FLC (88C7500)

RHYS-EVANS
Twin Fibre light carrier for above instrument (FLC) **88C7500**

FRASER LARYNGOSCOPES

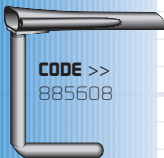

NEONATES & INFANTS
CODE >> 885608
Black finish with single side tube to carry FLC (88C4300)
proximal-18mm x14mm
distal-11mm x9mm
effective length-101mm



FOR CHILDREN 2-10yrs
CODE >> 885609
Black finish with single side tube to carry FLC (88C4300)
proximal-20mm x14mm
distal-13mm x12mm
effective length-101mm

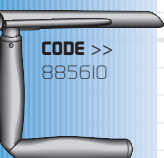

FOR SMALL ADULTS
CODE >> 885610
Black finish with single side tube to carry FLC (88C4300)
proximal-20mm x15mm
distal-14mm x13mm
effective length-138mm



FOR ADULTS WITH DIFFICULT TEETH
CODE >> 885612
Black finish with single side tube to carry FLC (88C4300)
proximal-20mm x15mm
distal-14mm x13mm
effective length-138mm

ADULT FOR ENDENTULOUS PATIENTS
CODE >> 885611
Black finish with single side tube to carry FLC (88C4300)
proximal-20mm x15mm
distal-14mm x13mm
effective length-138mm
NOT SHOWN

FIBRE LIGHT CARRIER 88C4300
single FLC for use with instruments shown (British standard 7.6mm connection will be supplied unless advised otherwise)

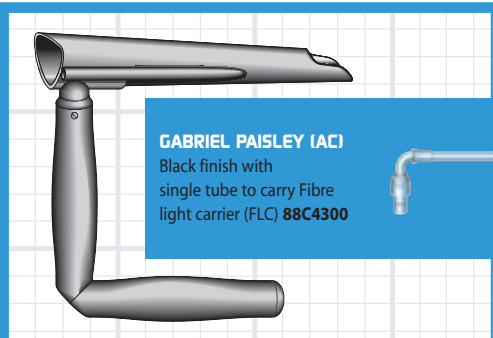

GABRIEL PAISLEY (AC)
Black finish with single tube to carry Fibre light carrier (FLC) **88C4300**

GABRIEL PAISLEY ANTERIOR COMMISSURE

NAME	SIZE	DESCRIPTION	FLC	SIZES	CODE
Gabriel Paisley (AC)	small	Black finish with single tube to carry FLC	88C4300	proximal-20mm x19mm distal-15mm x14mm effective length-120mm	885605
Gabriel Paisley (AC)	med	Black finish with single tube to carry FLC	88C4300	proximal-22mm x20mm distal-19mm x16mm effective length-150mm	885606
Gabriel Paisley (AC)	large	Black finish with single tube to carry FLC	88C4300	proximal-27mm x25mm distal-18mm x16mm effective length-150mm	885607

PLEASE NOTE: FLC- Fibre light carrier AC- Anterior commissure

+44 (0) 1258 471 770
+44 (0) 1258 471 772

TEL 01258 471770
FAX 01258 471772

Meditech Systems Limited
Unit 3 Richmar
Butt's Pond Ind.Estate
Sturminster Newton
Dorset DT10 1AZ

meditech
systems limited

FOR ALL ORDERS CALL DIRECT **0700 - 4 - MEDITECH**

NEGUS RANGE

NEGUS LARYNGOSCOPES-

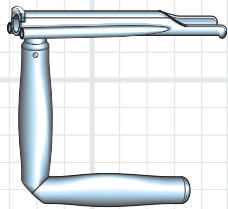

1 ADULT
CODE >> **SS884083**

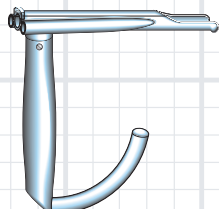

2 CHILD
CODE >> **SS884020**

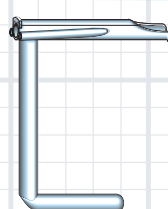

3 INFANT
CODE >> **SS884101**

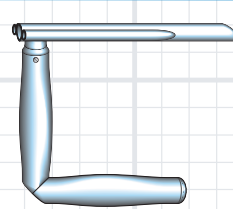

4 ADULT (AC)
CODE >> **SS884084**

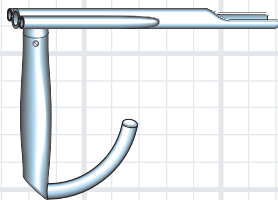

5 CHILD OESOPHAGAEI SPECULUM
CODE >> **SS884022**

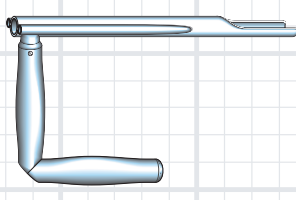

6 ADULT OESOPHAGAEI SPECULUM
CODE >> **SS884021**

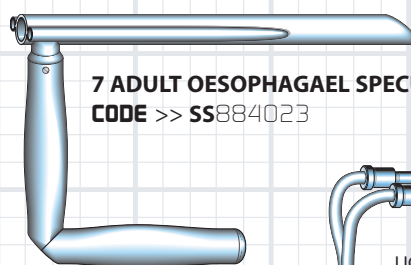

7 ADULT OESOPHAGAEI SPECULUM
CODE >> **SS884023**

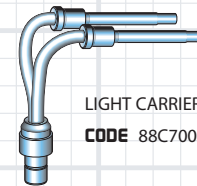

LIGHT CARRIER
CODE **88C700**

PRODUCT	DESCRIPTION	LUMEN SIZE	EFFECTIVE LENGTH	FINISH	CODE
Negus Adult No.1	with sliding panel & twin side tubes to carry FLC 88C700	15mm x 15mm	135mm	polished metal (PM) stainless steel (SS)	PM884083 SS884083
Negus Child No.2	with sliding panel & twin side tubes to carry FLC 88C800	12mm x 12mm	99mm	polished metal (PM) stainless steel (SS)	PM884020 SS884020
Negus Infant No.3	with sliding panel & twin side tubes to carry FLC 88C900	10mm x 10mm	82mm	polished metal (PM) stainless steel (SS)	PM884101 SS884101
Negus AC No.4	with twin side tubes to carry FLC 88C700	10.5mm x 9mm	145mm	polished metal (PM) stainless steel (SS)	PM884084 SS884084
Negus Child oesophagael speculum No.5	with long bevelled end & twin side tubes to carry FLC 88C800	12mm x 12mm	153mm	polished metal (PM) stainless steel (SS)	PM884022 SS884022
Negus Adult oesophagael speculum No.6	with long bevelled end & twin side tube to carry FLC 88C700	15mm x 15mm	222mm	polished metal (PM) stainless steel (SS)	PM884021 SS884021
Negus Adult oesophagael speculum No.7	with angled bevelled end with twin side to carry FLC 88C700	15mm x 15mm	207mm	polished metal (PM) stainless steel (SS)	PM884023 SS884023

NEGUS TRACHEASCOPE ADULT with twin side tube to carry FLC 88C800 11mm x 10mm Lumen, 218mm effective length polished metal PM884102 stainless steel SS884102
 NEGUS TRACHEASCOPE CHILD end with twin side tubes to carry FLC 88C900 7mm x 6mm Lumen, 157mm effective length polished metal PM884103 stainless steel SS884103

PLEASE NOTE: **AC- Anterior commissure FLC- Fibre Light Carrier**

meditech
systems limited

Meditech Systems Limited
Unit 3 Richmond
Butt's Pond Industrial Estate
Sturminster Newton
Dorset DT10 1AZ

Tel: +44 (0) 1258 471 770
Fax: +44 (0) 1258 471 772

FOR ALL ORDERS CALL DIRECT **0700 - 4 - MEDITECH**

26 >>

ENT instruments

ABBHEY NEEDLE

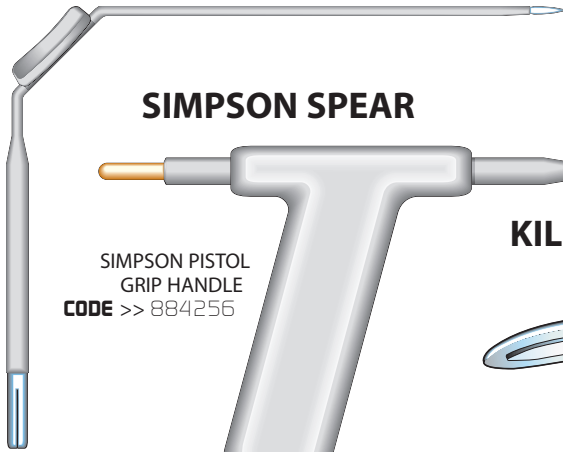

ABBHEY SUB-MUCOSAL NEEDLE **CODE** >> 885343

SIMPSON SPEAR



SIMPSON PISTOL GRIP HANDLE
CODE >> 884256

SIMPSON SUB-MUCOSAL ELECTRODE
CODE >> 884107

KILLIAN NASAL SPECULUM

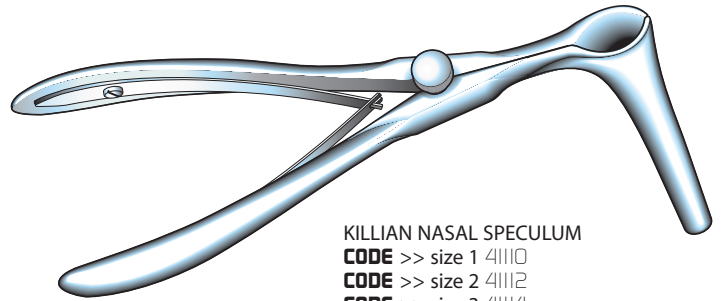

KILLIAN NASAL SPECULUM
CODE >> size 1 41110
CODE >> size 2 41112
CODE >> size 3 41114
CODE >> size 4 41116

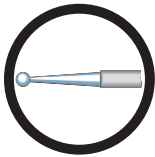

MICRO COAGULATION ELECTRODE

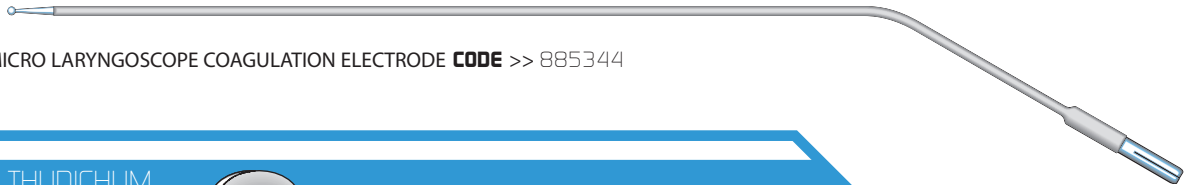

MICRO LARYNGOSCOPE COAGULATION ELECTRODE **CODE** >> 885344

THUDICHUM

- 0 CODE** >> 41120
- 1 CODE** >> 41121
- 2 CODE** >> 41122
- 3 CODE** >> 41123
- 4 CODE** >> 41124

NYLON INSULATED

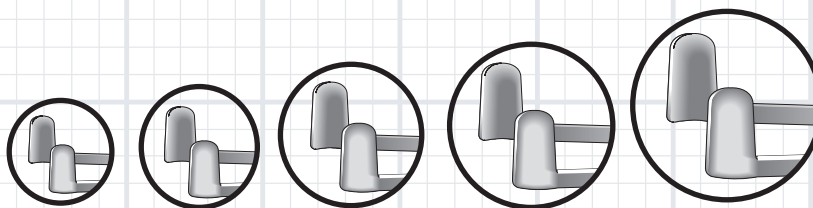

0 1 2 3 4



RE-INSULATION REPAIR SERVICE

+44 (0) 1258 471 770
+44 (0) 1258 471 772

TEL
FAX

Meditech Systems Limited
Unit 3 Richmar
Butt's Pond Ind.Estate
Sturminster Newton
Dorset DT110 1AZ

meditech
systems limited

FOR ALL ORDERS CALL DIRECT 0700 - 4 - MEDITECH

BRONCHOSCOPE FIBRE LOADER **CODE** >> 88C 100-C600

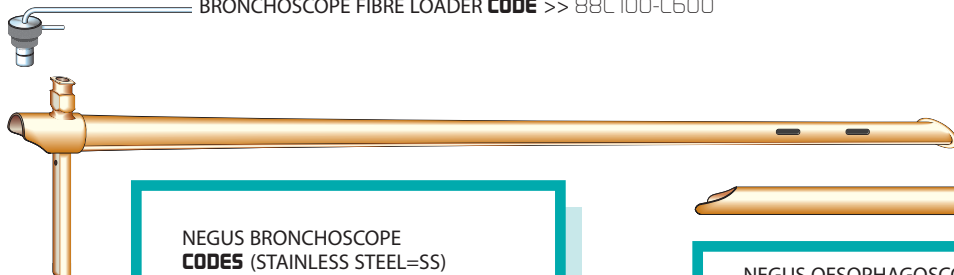

NEGUS BRONCHOSCOPE CODES (STAINLESS STEEL=SS)
 ADULT >> 88554085
 SML ADULT >> 88553042
 ADOLESCENT >> 88554024
 SML ADOLESCENT >> 88554281
 ADULT ASPIRATING >> 88554025
 CHILD >> 88554026
 CHILD ASPIRATING >> 88554027
 INFANT >> 88554028
 LOWER BRONCHUS >> 88554029
 SUCKLING >> 88554030
 SML SUCKLING >> 88554280
 SUCKLING SHORT >> 88554670

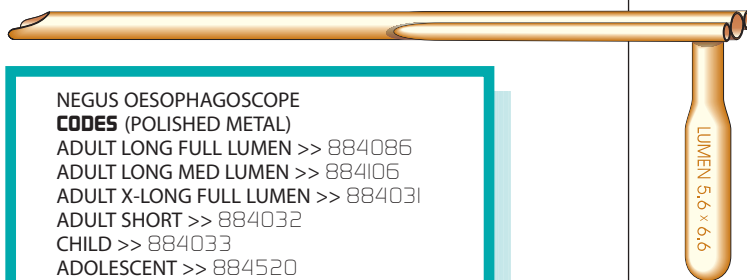

NEGUS OESOPHOSCOPE CODES (POLISHED METAL)
 ADULT LONG FULL LUMEN >> 884086
 ADULT LONG MED LUMEN >> 884106
 ADULT X-LONG FULL LUMEN >> 884031
 ADULT SHORT >> 884032
 CHILD >> 884033
 ADOLESCENT >> 884520
 ADOLESCENT SHORT >> 884521
 CHILD SHORT >> 884522
 INFANT >> 884523
 INFANT SMALL >> 884524

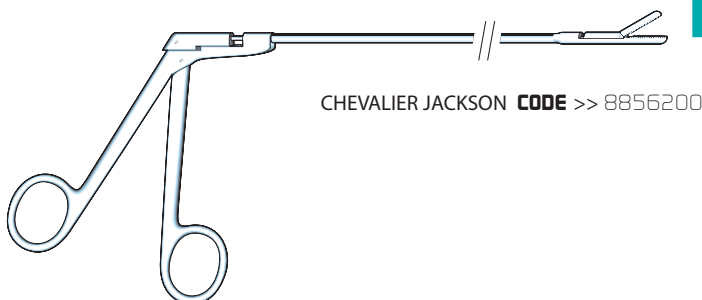

CHEVALIER JACKSON **CODE** >> 8856200

NEGUS OESOPHOSCOPE CODES (STAINLESS STEEL)
 ADULT LONG FULL LUMEN >> 88554086
 ADULT LONG MED LUMEN >> 88554106
 ADULT X-LONG FULL LUMEN >> 88554031
 ADULT SHORT >> 88554032
 CHILD >> 88554033
 ADOLESCENT >> 88554520
 ADOLESCENT SHORT >> 88554521
 CHILD SHORT >> 88554522
 INFANT >> 88554523
 INFANT SMALL >> 88554524

CAUTERY

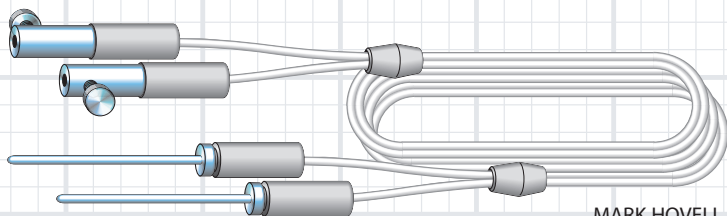

MARK HOVELL CAUTERY CABLE
CODE >> 834003

MARK HOVELL
CAUTERY HANDLE
CODE >> 834002

MARK HOVELL CAUTERY
ELECTRODES

- 1 **CODE** >> 834000B
- 2 **CODE** >> 834000E
- 3 **CODE** >> 834000I
- 4 **CODE** >> 834000A
- 5 **CODE** >> 834000F
- 6 **CODE** >> 834000C

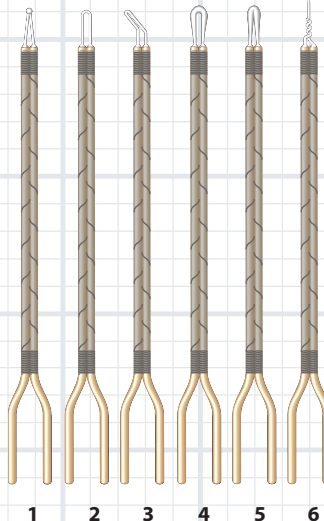
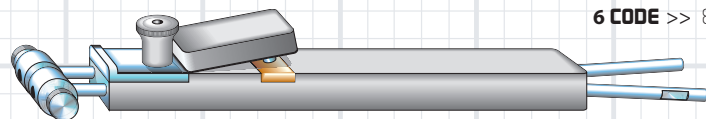

FOR ALL ORDERS CALL DIRECT 0700 - 4 - MEDITECH

LLYOYD-DAVIES SIGMOIDOSCOPE

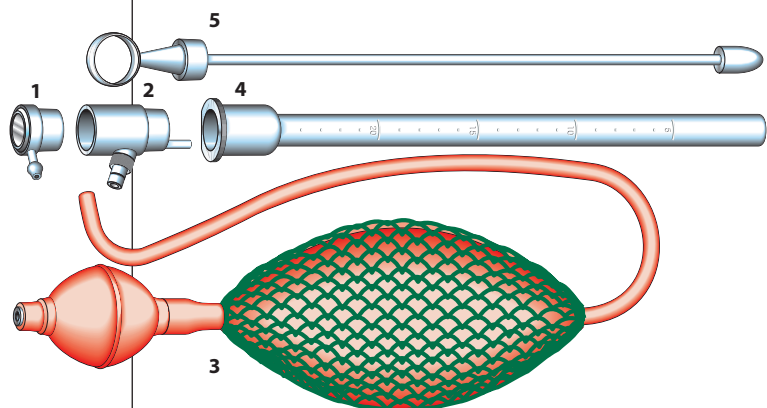

FIBRE LIGHT CARRIER
CODE >> 85C 1600

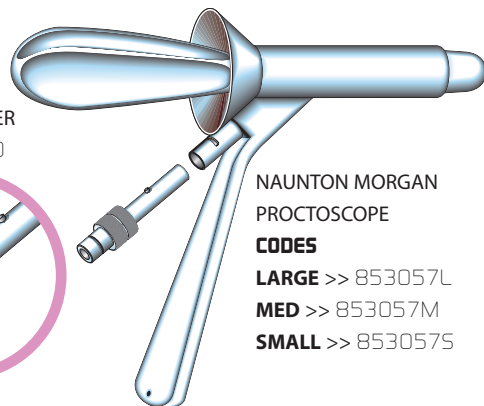

NAUNTON MORGAN
PROCTOSCOPE

CODES

LARGE >> 853057L

MED >> 853057M

SMALL >> 853057S

1 INFLATION WINDOW

CODE >> 851001

2 FIBRE ILLUMATED PROJECTION HEAD

CODE (ADULT) >> 851002

3 INFLATION BELLOWS

CODE >> 851005

4 CANULAR ONLY

CODE (ADULT) >> 851005

CODE (CHILD) >> 851006

5 OBTURATOR

CODE (ADULT) >> 851003

CODE (CHILD) >> 851004

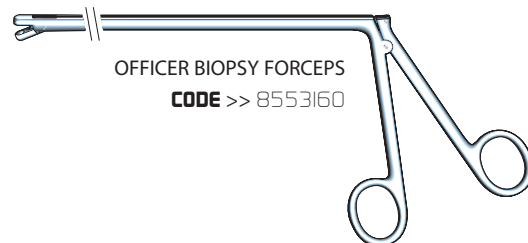

OFFICER BIOPSY FORCEPS

CODE >> 8553160

PROCTOLOGY ACCESSORIES

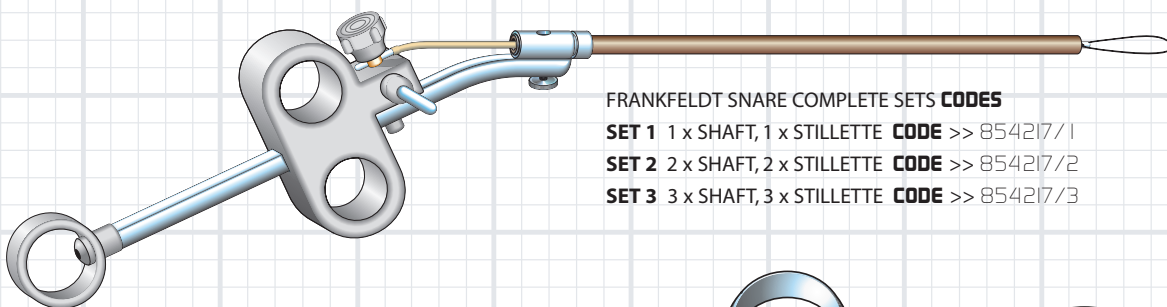

FRANKFELDT SNARE COMPLETE SETS **CODES**

SET 1 1 x SHAFT, 1 x STILLETTE **CODE** >> 854217/1

SET 2 2 x SHAFT, 2 x STILLETTE **CODE** >> 854217/2

SET 3 3 x SHAFT, 3 x STILLETTE **CODE** >> 854217/3

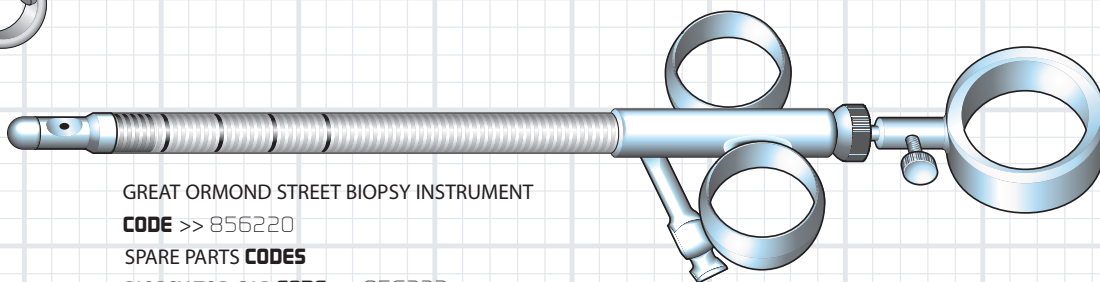

GREAT ORMOND STREET BIOPSY INSTRUMENT

CODE >> 856220

SPARE PARTS CODES

BIOPSY TOP CAP **CODE** >> 856223

CUTTING CUPS **CODE** >> 856226

THUMB RING SCREW **CODE** >> 856224

KNURLED RETENTION RING **CODE** >> 856222

O RING **CODE** >> 856225

SYRINGE CONNECTION **CODE** >> 856221



+44 (0) 1258 471 770
+44 (0) 1258 471 772

TEL
FAX

Meditech Systems Limited
Unit 3 Richmar
Butt's Pond Ind.Estate
Sturminster Newton
Dorset DT10 1AZ

meditech
systems limited

INTERNAL DEFIBRILLATOR & FIBRILLATOR CABLES

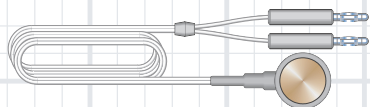

FIBRILLATOR LEAD DOUBLE SIDED ELECTRODE
CODE >> 225982

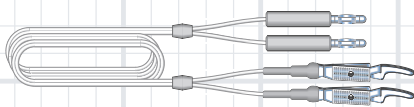

FIBRILLATOR LEAD 2 BULLDOG CLAMPS
CODE >> 225984

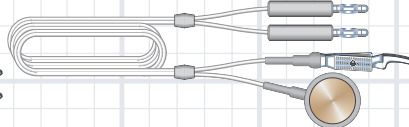

FIBRILLATOR LEAD SINGLE SIDED ELECTRODE
CODE >> 225980

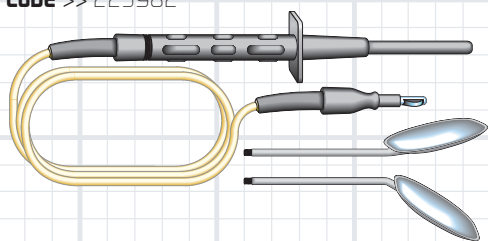

INTERNAL DEFIBRILLATOR SET **CODE >> 225994**

SPARE PARTS **CODES**

CABLE **CODE >> 225986**

PADDLE W/O INSULATED

SHAFT **CODE >> 225988**

INTERNAL HANDLE

CODE >> 225990

INSULATED SHAFT

CODE >> 225992

DOUBLE ENDED BONE LEVER **CODE >> 851500**

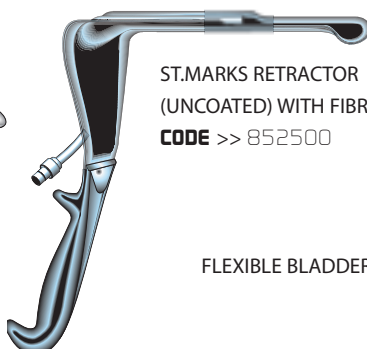

ST.MARKS RETRACTOR (UNCOATED) WITH FIBRE LIGHT
CODE >> 852500



ADULT LEAD HAND
CODE >> 853500

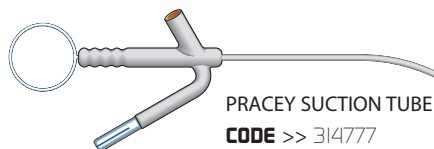

PRACEY SUCTION TUBE
CODE >> 314777

FLEXIBLE BLADDER ELECTRODE COLOUR CODED

4CH CODE >> 443614

5CH CODE >> 443615

6CH CODE >> 443616

7CH CODE >> 443617

8CH CODE >> 443618

9CH CODE >> 443619

10CH CODE >> 443610

DIATHERMY QUIVERS

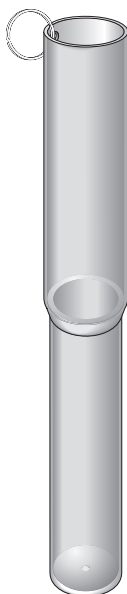

QUIVER 65mm DIAMETER x 400m LENGTH - TELESCOPIC
CODE >> 1565400



QUIVER 40 mm DIAMETER x 235m LENGTH
CODE >> 1540235



QUIVER 65mm DIAMETER x 190m LENGTH
CODE >> 15195190



QUIVER 65mm DIAMETER x 235m LENGTH
CODE >> 1595235

SLOAN ROBERTS SUCTION COAGULATOR

CODE >> 31458S (1mm dia)

CODE >> 31458M (2mm dia)

CODE >> 31458L (3mm dia)

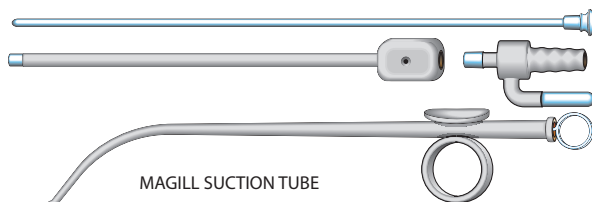

MAGILL SUCTION TUBE

CODE >> 314578S (3mm dia)

CODE >> 314578M (3.5mm dia)

CODE >> 314578L (4mm dia)

30 >>
Light cables



“MULTI-FIT” LIGHT CABLES

LIGHTSOURCE CONNECTION

INSTRUMENT CONNECTION

AVAILABLE WITH FIXED OR REMOVABLE END CONNECTORS

LIGHT CABLES		DESCRIPTION
LIGHTSOURCE CONNECTION	INSTRUMENT CONNECTION	
		<p>LIGHTSOURCE CONNECTORS</p> <ol style="list-style-type: none"> ACMI (AFI, Aspen, Cuda, Eder, KLI, Lutex, Pilling, Stryker, V.mueller, Wehmer, Z immer). WOLF DYONICS WOLF EXTENDED KARL STORZ OLYMPUS (5.0 MAX. BUNDLE DIA) OLYMPUS PILLING - 6 (3.5 MAX. BUNDLE DIA) DESIGNS FOR VISION MACHIDA PENTAX <p>INSTRUMENT CONNECTORS</p> <ol style="list-style-type: none"> ACMI (AFI, Aspen, Cuda, Eder, KLI, Lutex, Pilling, Stryker, V.mueller, Wehmer, Z immer). WOLF DYONICS KARL STORZ OLYMPUS ACMI-1 (AFI, Aspen, Cuda, Eder, KLI, Lutex, Pilling, Stryker, V.mueller, Wehmer, Z immer). WOLF DYONICS CLIP SCHOLLY KARL STORZ OLYMPUS (5.0 MAX. BUNDLE DIA) PILLING DESIGNS FOR VISION ACMI MALE ACMI CLIP-ON ACMI 45° MALE ACMI 90° MALE <p>CABLE LENGTHS: 180/225/275CM</p>

+44 (0) 1258 471 770
+44 (0) 1258 471 772

TEL 00
FAX 00

Meditech Systems Limited
Unit 3 Richmar
Butt's Pond Ind.Estate
Sturminster Newton
Dorset DT10 1AZ



FIBREOPTIC BUNDLE SIZE (mm)

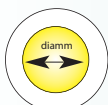

CABLE END VIEW



Available from 2mm to 6.5mm diameter

CODING FORMAT EXAMPLE

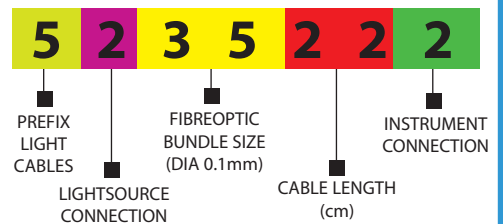
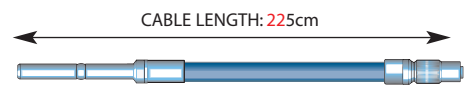

FOR ALL ORDERS CALL DIRECT **0700 - 4 - MEDITECH**

LIGHT CARRIERS

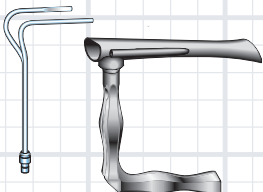

LIGHT CARRIER FOR RHYS-EVANS MICRO LARYNGOSCOPE
CODE >> 88C7500

Example of light carrier fitting to Rhys - Evans micro laryngoscope
Custom styles available

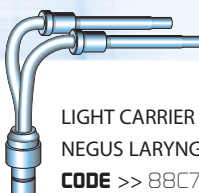

LIGHT CARRIER FOR USE WITH NEGUS LARYNGOSCOPE
CODE >> 88C700

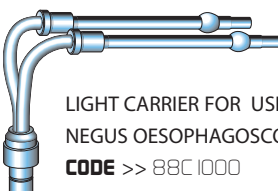

LIGHT CARRIER FOR USE WITH NEGUS OESOPHOSCOPES
CODE >> 88C1000

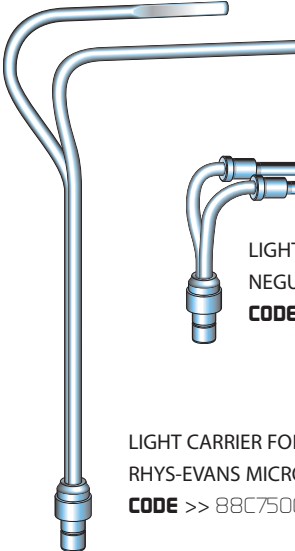

LIGHT CARRIER FOR USE WITH RHYS-EVANS MICRO LARYNGOSCOPE
CODE >> 88C7500

FIBRE LOADING REPAIR SERVICE



SCOPE REPAIR SERVICE



LIGHT CARRIER FOR USE WITH RNTNE BLACKENED LARYNGOSCOPES
CODE >> 88C4300

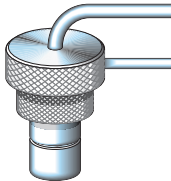

LIGHT CARRIER FOR USE WITH NEGUS BRONCHOSCOPES
CODES:

- 88C100** 40cm (2mm dia)
- 88C200** 30cm (2mm dia)
- 88C300** 27.5cm (2mm dia)
- 88C400** 45cm (2mm dia)
- 88C500** 27.5cm (1.6mm)
- 88C600** 18cm (2mm dia)

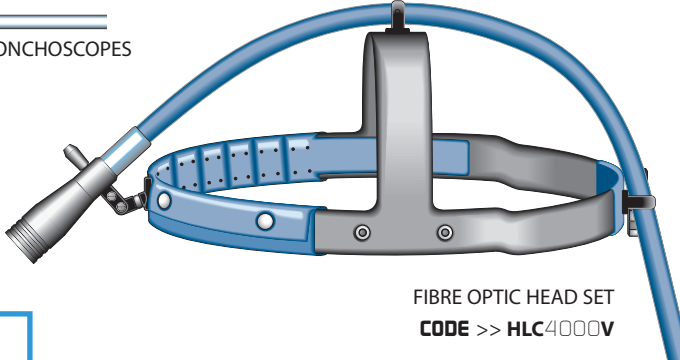

FIBRE OPTIC HEAD SET
CODE >> HLC4000V

LIGHT CARRIERS

CODE	SIZE	COMPATIBLE INSTRUMENT
fibre light carriers for bronchoscopes		
88C100	40cm	SS4085-SS3042-SS4024-SS4281-SS4025*
88C200	30cm	SS4026-SS4027
88C300	27.5cm	SS4028
88C400	45cm	SS4029
88C500	27.5cm	SS4030-SS4280
88C600	18cm	SS4670
Twin fibre light carriers for laryngoscopes		
88C700	—	SS4083-SS4021-SS4023*
88C7A00	—	SS4084
88C800	—	SS4020-SS4022
88C8A00	—	SS4102
88C900	—	SS4101
88C9A00	—	SS4103
88C1000	—	SS4086-SS4031*
88C10A00	—	SS4106
88C10B00	—	SS4032
88C1100	—	SS4520-SS4521
88C11A00	—	SS4033-SS4522
88C1200	—	SS4523
88C1300	—	SS4524

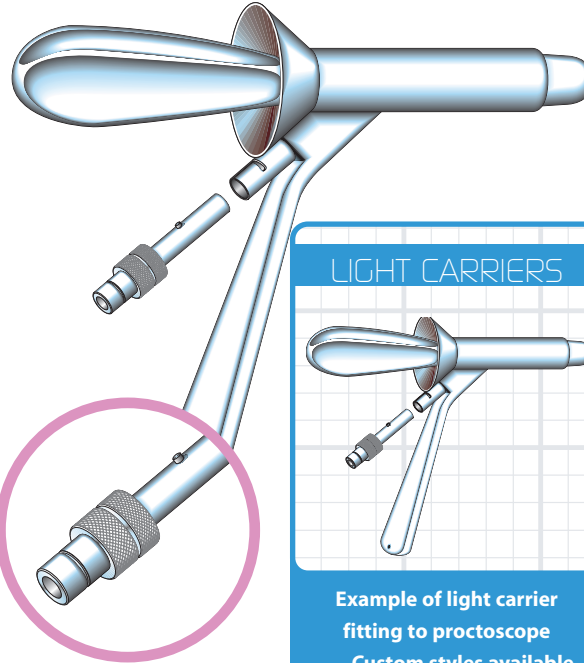

CODE >> 88C1600

LIGHT CARRIERS

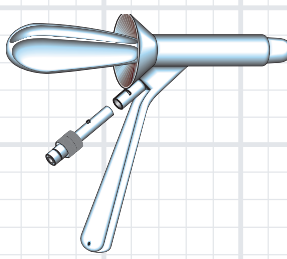

Example of light carrier fitting to proctoscope
Custom styles available

*PLEASE NOTE:
Above fibre light carriers will fit both polished metal and stainless steel instruments

32 >>

Laparoscopic
electrodes & scissors

BIPOLAR

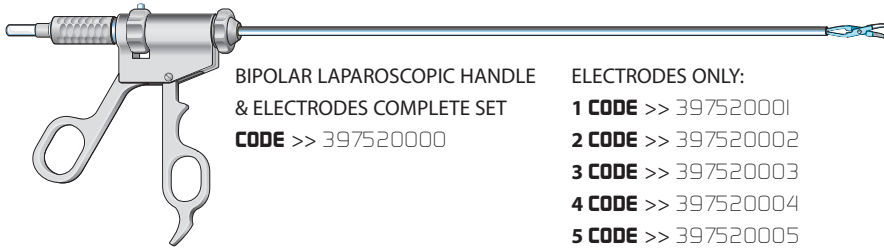

BIPOLAR LAPAROSCOPIC HANDLE
& ELECTRODES COMPLETE SET
CODE >> 397520000

ELECTRODES ONLY:
1 CODE >> 397520001
2 CODE >> 397520002
3 CODE >> 397520003
4 CODE >> 397520004
5 CODE >> 397520005
6 CODE >> 397520006

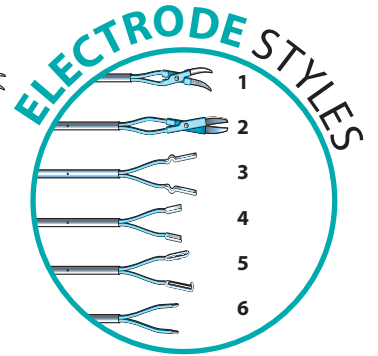

MONOPOLAR

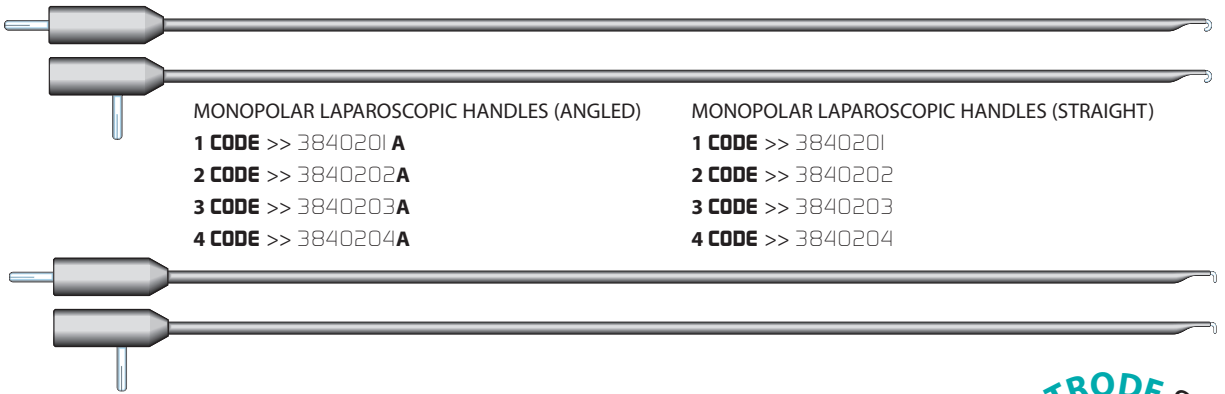

MONOPOLAR LAPAROSCOPIC HANDLES (ANGLED)
1 CODE >> 3840201A
2 CODE >> 3840202A
3 CODE >> 3840203A
4 CODE >> 3840204A

MONOPOLAR LAPAROSCOPIC HANDLES (STRAIGHT)
1 CODE >> 3840201
2 CODE >> 3840202
3 CODE >> 3840203
4 CODE >> 3840204

LAPAROSCOPIC ELECTRODES

compatible with hand control pencils



1 CODE >> 3124200H
2 CODE >> 3124200HD
3 CODE >> 3124200B

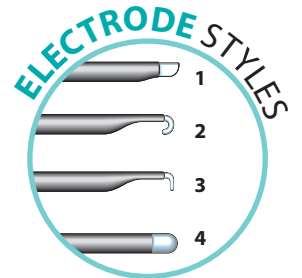

2 single use option
please use prefix SU

wherever you see this logo
please note that you have
the option of single -use on
products shown

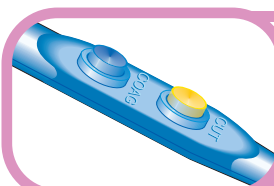

HAND CONTROL PENCILS

ALLOWING FINGER CONTROL IN
LAPAROSCOPIC PROCEDURE
SEE PAGE 4

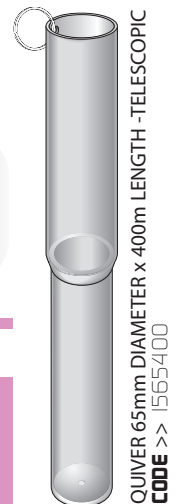

QUIVER 65mm DIAMETER x 400m LENGTH -TELESCOPIC
CODE >> 1565400

+44 (0) 1258 471 770
+44 (0) 1258 471 772

TEL
FAX

Meditech Systems Limited
Unit 3 Richmar
Butt's Pond Ind.Estate
Sturminster Newton
Dorset DT10 1AZ

meditech
systems limited

REPAIR SERVICES FIBRE OPTICS



- POLISHING
- FIBRE LOADING
- SCOPE REPAIRS

REPAIR SERVICES INSULATION

- NYLON INSULATION
- ELECTRO STATIC SPRAYING
- INSULATION THICKNESS TESTING
- INSULATION PINHOLE TESTING



- RE-INSULATION REPAIR SERVICE
- RE-INSULATION REPAIR SERVICE
- RE-INSULATION REPAIR SERVICE

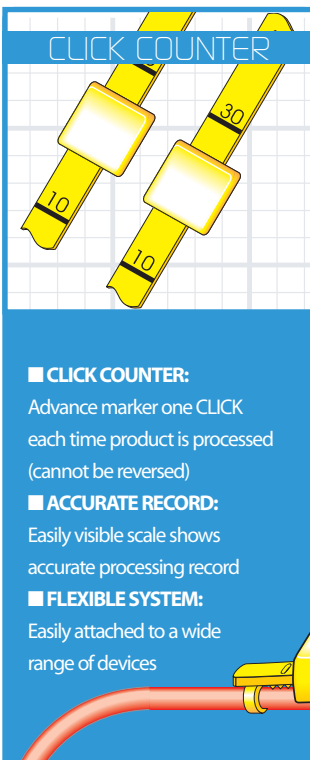

CLICK COUNTER

- **CLICK COUNTER:**
Advance marker one CLICK each time product is processed (cannot be reversed)
- **ACCURATE RECORD:**
Easily visible scale shows accurate processing record
- **FLEXIBLE SYSTEM:**
Easily attached to a wide range of devices

DIATHERMY CABLE SERVICES

MONOPOLAR & BIPOLAR

- TRACKING COUNTERS (CLICK COUNTER)
- ELECTRICAL CONTINUITY TESTING
- INSULATION TESTING
- CABLE REPAIRS

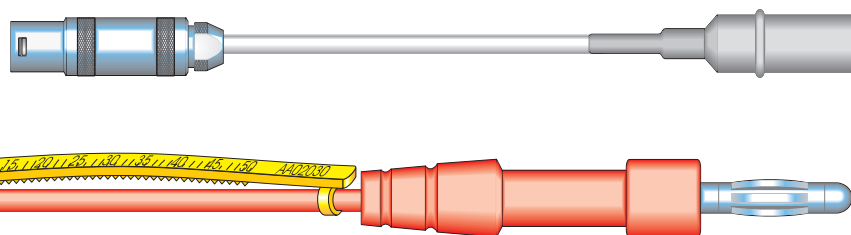

FOR ALL ORDERS CALL DIRECT 0700 - 4 - MEDITECH

ANAESTHESIA CIRCUITS & ACCESSORIES

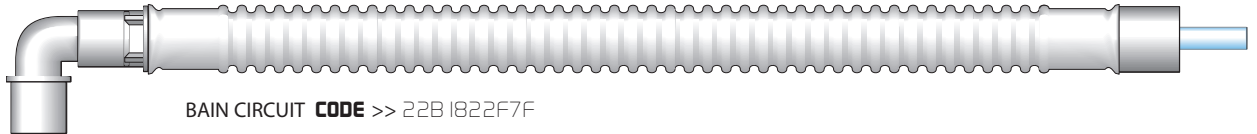

BAIN CIRCUIT **CODE** >> 22B 1822F7F

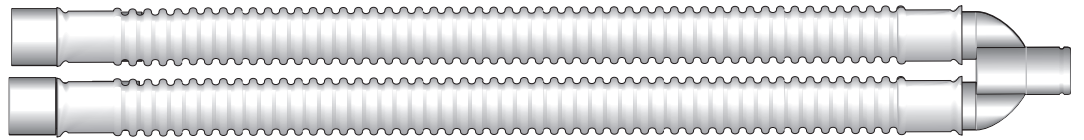

PARRELEL "Y" CIRCUIT **CODE** >> 22P 1822FF

CATHETER MOUNT DOUBLE SWIVEL ELBOW

CODE >> 22150DS

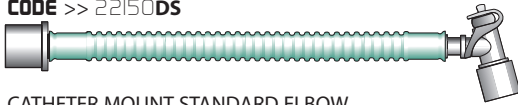

CATHETER MOUNT STANDARD ELBOW

CODE >> 22150S



CATHETER MOUNT GAS SAMPLING ELBOW

CODE >> 22150GS

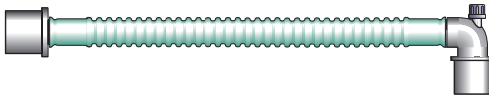

SCAVENGING TUBING

Scavenging tubing available in 22mm & 15mm with cuff intervals to customer requirements

ANAESTHESIA FACE MASK

CODE >> 22005

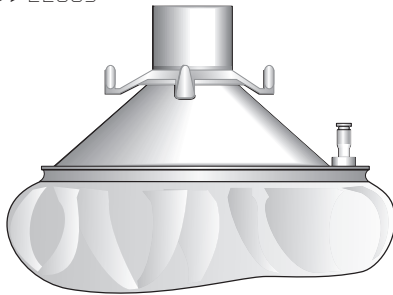

LATEX FREE!

RE-BREATHING BAGS

- | | |
|----------------------------|--------|
| 1 CODE >> 1/2 LITRE | 221025 |
| 2 CODE >> 1 LITRE | 221050 |
| 3 CODE >> 2 LITRE | 221100 |
| 4 CODE >> 3 LITRE | 221200 |
| 5 CODE >> 3 LITRE | 221300 |

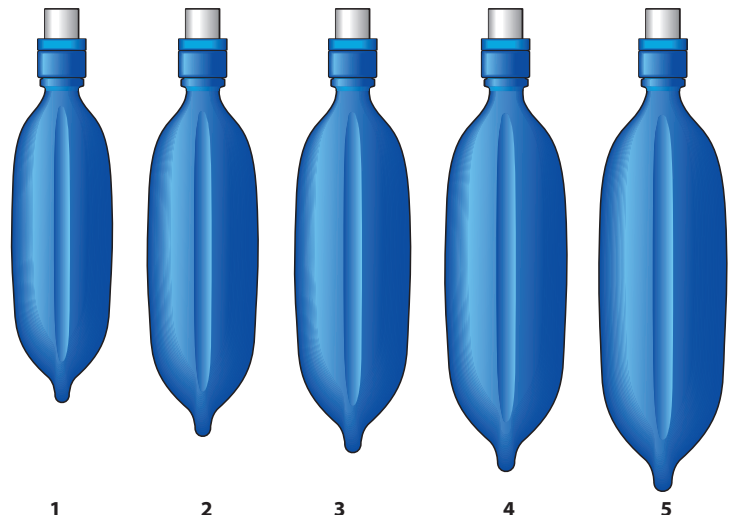

1

2

3

4

5

+44 (0) 1258 471 770
+44 (0) 1258 471 772



Meditech Systems Limited
Unit 3 Richmar
Butt's Pond Ind.Estate
Sturminster Newton
Dorset DT10 1AZ

meditech
systems limited

OXYGEN THERAPY PRODUCTS

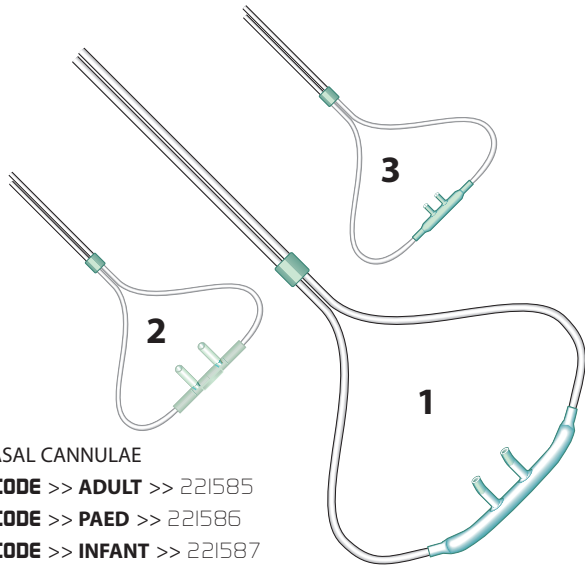

NASAL CANNULAE

1 CODE >> ADULT >> 221585

2 CODE >> PAED >> 221586

3 CODE >> INFANT >> 221587



AEROSOL MASK
CODE >> 221426



FACE TENT MASK
CODE >> 221490



OXYGEN MASK
CODE >> 221420

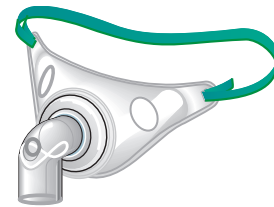

TRACHEOSTOMY MASK
CODE >> 222400

OXYGEN TUBING

STANDARD LUMEN

STAR LUMEN

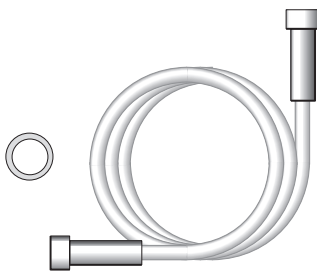

OXYGEN TUBING
CODE >> 221103

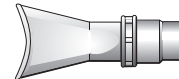

MOUTHPIECE
CODE >> 221200

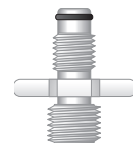

BOC ADAPTER
CODE >> 22810158

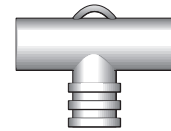

BOC ADAPTER
CODE >> 221575

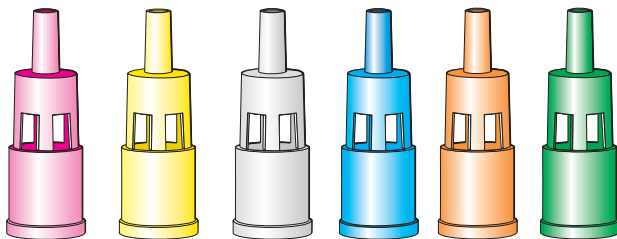

VENTURI JETS

1 CODE 24% >> 221024

2 CODE 28% >> 221028

3 CODE 31% >> 221031

4 CODE 35% >> 221035

5 CODE 40% >> 221040

6 CODE 50% >> 221050

7 CODE 60% >> 221060

CORRUGATED TUBING

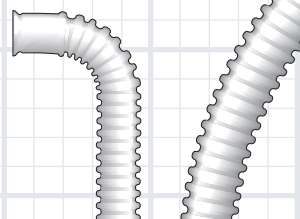

Corrugated tubing available in 22mm & 15mm with cuff intervals to customer requirements

meditech
Systems Limited

Meditech Systems Limited
Unit 3 Richmond
Butt's Pond Industrial Estate
Sturminster Newton
Dorset DT10 1AZ

Tel +44 (0) 1258 471 770

Fax +44 (0) 1258 471 772



HOW TO ORDER

- QUOTE PAGE NUMBER & PRODUCT CODE
- QUOTE PRODUCT QUANTITY
- QUOTE DELIVERY ADDRESS

SEND TO CUSTOMER SERVICE:

BY POST TO: Meditech Systems Limited
Unit 3 Richmar
Butt's Pond Ind.Estate
Sturminster Newton
Dorset DT10 1AZ UK
FOR ALL ORDERS CALL DIRECT

BY PHONE: 0700 - 4 - MEDITECH
+44(0)1258 471 770

BY FAX: +44(0)1258 471 772

BY EMAIL: sales@electrosurgery.co.uk



ICAN Software Limited
ican@electrosurgery.co.uk



Directive design...

- catalogues
- brochures
- plus much more!

contact coleen on
07949 997 794